NEW HOUSING OPTIONS

FOR PEOPLE WITH SIGNIFICANT DISABILITY

DESIGN INSIGHTS

Supported by



Prepared by:

Sophie Ryan, Astrid Reynolds
Summer Foundation Ltd
ABN 90 117 719 516
PO Box 208
Blackburn 3180
VIC Australia

Telephone: +613 9894 7006
Fax: +613 8456 6325
info@summerfoundation.org.au
www.summerfoundation.org.au

Citation Guide

Ryan, S., Reynolds, A., (2015), *New housing options for people with significant disability – Design Insights*,
Melbourne: Summer Foundation Ltd.



© 2015 by the Summer Foundation Ltd. A copy of this report is made available under a Creative Commons Attribution 4.0 License (international)

ISBN 978-0-980-5980-6-3

ACKNOWLEDGEMENTS

We wish to thank the following individuals and organisations for providing supporting images, as follows:

Fred Kroh
Common Equity Housing Ltd (CEHL)
BaseBuild Pty Ltd
Aja Goddard, BCA Access Solutions

Summer Foundation Ltd wishes to acknowledge the generous financial support of Colonial Foundation, which made the production of this report possible.

**DISCLAIMERS**

The Summer Foundation has contributed information towards this report and believes it to be accurate and reliable. Neither the Summer Foundation nor any of its collaborators make any warranty, expressed or implied, regarding any information, including warranties to the accuracy, validity or completeness of the information. This report is for educational purposes and the Summer Foundation cannot be held responsible for any actions taken on the basis of information outlined in this report.

CONTENTS

PART 1 – HOUSING AND SUPPORT OVERVIEW OF APPROACH 5

1. INTRODUCTION 6

Summer Foundation About Us	6
Our work in housing	6
Report focus	7
Report structure	7
Collaborative process of learning	8

2. HOUSING AND SUPPORT DEMONSTRATION PROJECTS 9

Purpose of the projects	9
First two projects overview	10
The Hunter target group	12
General housing features	13
Support model features	14
Action learning and formal evaluation	15

3. KEY DESIGN FRAMEWORKS 16

Core objectives	16
Universal design principles	18
Livable housing design guidelines	19
Beyond existing standards	20

PART 2 – HOUSING DESIGN DETAILED CONSIDERATIONS 21

A. KEY DESIGN FEATURES

THE HUNTER APARTMENTS 22

Allowing for real life opportunities	22
Accessibility	23
Supporting dignity	24
Additional features	24
Customisable features for individual needs	25
Home automation technology	26
Safety features supporting independent living	27
Minimising future cost	28

B. COMMON AREAS 29

Design enhancements	29
Ancillary features and facilities	31

C. APARTMENT SELECTION CRITERIA 32

D. KEY SPACES | DESIGN AND ADAPTABILITY FEATURES 35

Abbotsford project learnings	38
Accessible bathrooms	46

Kitchens	53
Accessible bedrooms	63
Private outdoor areas	65
Other spaces and provisions	68

E. IDEAL PRODUCT FEATURES 70

F. TECHNOLOGY 76

Emergency communication system	76
Home automation and monitoring system	77
System Features – Ease of operation	78

G. LINKING INDIVIDUAL CAPACITY WITH BUILT ENVIRONMENT 79

H. ASSISTIVE EQUIPMENT TO SUPPORT EASE OF USE 83

APPENDICES/ RESOURCES 84

1. Hunter Project – Apartment floor plans	84
2. Principles in decision-making – joinery & window furnishings	87
3. Ceiling hoists	90
4. Emergency call workflow	93

GLOSSARY

Below is a list of building-related terms and abbreviations used in this report:

ABS edging	Toughened thermoformed edging on joinery
BIR	Built in robe
BPN rating	“British Pendulum Number” slip-rating; uses the Wet Pendulum Test method, which is appropriate for smooth soles shoes in wet areas (R-rating slip levels are relevant for profiled safety boots on oily floors)
Chamfered edge	A square edge or corner that is cut away symmetrically (generally to be more ergonomic)
Commode	An assistive mobility device, either wheeled over a toilet or used in a shower
GPO	General power outlet (power point)
Induction cooktop	Electric cooktop surface, which only heats up in areas where a pan is placed, and quickly cools once a pan is removed, reducing risks of burns for people with limited strength or sensory abilities
Infrared (IR)	A type of wireless signal that uses invisible infrared light; the type of signal commonly used in television remote controls. It has a range of several metres, and requires ‘line of sight’ between the remote control and the receiver.
PVC	Low-cost plastic plumbing product, can be flexible or rigid
Radio frequency (RF)	A type of wireless signal that uses radio waves; the type of signal often used in garage door remote controls. It has a long range and can pass through walls or other objects

ABBREVIATIONS

BCA	Building Code of Australia	LHA	Livable Housing Australia	RIPL	Residential Independence Pty Ltd
DDA	Disability Discrimination Act	LHD	Livable Housing Design	TAC	Transport Accident Commission
		NDIS	National Disability Insurance Scheme		



PART I HOUSING AND SUPPORT

OVERVIEW OF APPROACH

1. INTRODUCTION
2. HOUSING AND SUPPORT DEMONSTRATION PROJECTS
3. KEY DESIGN FRAMEWORKS



Large apartment (above) and view toward central landscaped courtyard (below), Abbotsford Housing Demonstration Project.

1. INTRODUCTION

SUMMER FOUNDATION | ABOUT US

The Summer Foundation, established in 2006, is an organisation that works to change the human services policies and practices related to young people living in, or at risk of, entering residential aged care (RAC) facilities. Summer Foundation's vision is that young people with disability and complex support needs will have inherent value as members of our society, with access to services and housing that supports their health and wellbeing.

The Summer Foundation is working in three key ways to support change.

▶ **Creating a movement:**

We support people with disability to tell their story to raise awareness and keep the issue on the political and public agenda.

▶ **Building an evidence base:**

We conduct and foster research that provides an evidence base for policy and practice change.

▶ **Housing:** We establish, evaluate and document demonstration projects in order to encourage others to replicate the model to increase the range and number of housing and support options.



OUR WORK IN HOUSING

One of the reasons young people remain living in residential aged care facilities is that there are limited suitable housing options for them. While the recent introduction of the National Disability Insurance Scheme (NDIS) means that people can get funding for support and equipment, without more accessible and affordable housing options, few will move out of residential aged care.

The Summer Foundation is developing a small number of integrated housing and support demonstration projects to test and refine a new innovative housing and support option for young people in or at risk of entering residential aged care facilities. In 2013 the Summer Foundation established its first demonstration project in Abbotsford, Victoria. The Summer Foundation is now establishing a second project in the NSW Hunter NDIS trial site. This project is building on our learning from the Abbotsford Demonstration Project.

In our demonstration projects, one area of emphasis has been on apartment design that supports the independence and inclusion of people with significant disabilities in the community. There has also been a focus on incorporating smart home technology as a way of enhancing the opportunities for more independent living.

The Summer Foundation has a strong commitment to sharing knowledge gained through our housing projects. The development of this report is part of that commitment.

REPORT FOCUS

Developing the design and technology specification for our two housing demonstration projects has been a learning journey, which continues. This document is not a detailed design guide; rather it is a document that presents our learnings to date, outlining in particular key **accessibility, adaptability** and **technology features** included in the project apartments.

From our Abbotsford Demonstration Project we learnt how design detail and customisation in response to a tenant's specific capacities and disabilities can have a very significant impact on what tenants can do for themselves. Thus, the apartments in our second demonstration project have been designed to have a number of features that can be adaptable in a cost effective manner to meet the needs of individual tenants. Several of these adaptive features are outlined in detail.

This report also provides an overview of the **key design frameworks** that have underpinned our approach and documents some of the specific design elements we have included in the apartments as a result of these. We anticipate that this information will be of use to others who are involved in planning housing, as well as those who wish to increase their awareness of how design can assist in the provision of new housing options for this target group.

We hope that this document will increase understanding of issues around providing housing for people with more significant disabilities. Increasing the range of housing options suitable for this target group is an imperative if we are to ensure that they can share in the full benefit of the new National Disability Insurance Scheme.

“ WE HOPE THAT THIS DOCUMENT WILL INCREASE UNDERSTANDING OF A RANGE OF ISSUES IN PROVIDING HOUSING FOR PEOPLE WITH MORE SIGNIFICANT DISABILITIES. ”

REPORT STRUCTURE

This report has two parts:

Part 1 sets out the background information about the Summer Foundation Housing Demonstration Projects. It provides an overview of four interlinked key aspects of the demonstration projects: the target group, the housing; the support model features; and research and evaluation. In Section 3 there is an outline of key frameworks that have influenced the design approach, highlighting the strong emphasis on supporting people with significant disabilities to live an independent and included life.

Part 2 has been developed to provide insights into specific aspects of the design and the considerations that have influenced design. The aim of this section is to provide a number of more practical resources to support understanding of our approach and how design can support a person to be more independent in their home.

COLLABORATIVE PROCESS OF LEARNING

The Summer Foundation has had the privilege to work in collaboration with a number of organisations and individuals who have a similar interest in improving the design of housing for people with significant disabilities. Through information sharing and collaborative endeavours we continue to progress our understanding together of effective design strategies that support people with significant disabilities in living with greater independence.

We would like to particularly acknowledge the work of the Transport Accident Commission's (TAC) Residential Independence Pty Ltd (RIPL), who were collaborators in our first demonstration project. Justin Nix from RIPL has been very generous with his feedback on our design thinking during specification development of our second demonstration project. We also wish to acknowledge MSM Architects, who have undertaken the architectural work in a number of recent more innovative housing projects for people with significant disabilities. Michele Cobelens and Ashleigh Darville from MSM Architects have worked closely with the Summer Foundation on the specifications for our second demonstration project. We also wish to acknowledge the feedback on design ideas from John Carter of Housing Choices Australia.

We would also like to acknowledge the helpful insights of Scott Shafren and Luke Mahaffey from BaseBuild Pty Ltd, Scott Kelly from SKE Electrical, David Nadin from NadinWest Joinery and Aja Goddard from BCA Access Solutions, into various issues that impact on design.

A number of people have supported us in developing an understanding of technology and its role in supporting people with disability, and we would like to thank them all for their enthusiasm and patience: Craig Peacock, Flinders University; Chris Hart van Arends and Chris Marks, C Squared Automation; and Nathan Gill from Automated Innovation.



2. HOUSING AND SUPPORT DEMONSTRATION PROJECTS

This section of the report provides an overview of the Summer Foundation's integrated housing and support demonstration projects. It sets out the purpose of establishing the projects, their target group and core features.

As outlined in the introductory section, the Summer Foundation is establishing a small number of integrated housing and support demonstration projects to test and refine new options for young people in or at risk of entry to residential aged care facilities.

The Summer Foundation has a strong focus on disseminating information widely about the demonstration projects in order to raise awareness and encourage others to replicate the model. This report is an example of the focus on information dissemination.

PURPOSE OF THE PROJECTS

The work on these projects continues to contribute to understanding the design, technology, support approaches and partnerships required to provide sustainable new options. If we have a wider range of housing and support options, young people can move out of residential aged care facilities, or in the future, may never need to move into one because there are appropriate alternatives available.

The introduction of the NDIS, with its focus on participant independence, inclusion and control alongside a focus on lifetime care costs, rather than short term care costs, provides a new environment within which to test and refine innovative housing and support approaches. It provides the opportunity for thinking in an integrated way about how location, building design, technology and the support approach can work together to support greater capacity for independence and for inclusion. It also provides the opportunity to examine the cost saving potential on lifetime care costs.

The demonstration models being developed by the Summer Foundation have a very strong focus on supporting people to:

- Be as independent and included as possible
- Have as much control over their home environment as possible
- Have a home environment that can support maintenance of family roles and contact with friends and family.

“ THE SUMMER FOUNDATION HAS A STRONG FOCUS ON DISSEMINATING INFORMATION WIDELY ABOUT THE DEMONSTRATION PROJECTS IN ORDER TO RAISE AWARENESS AND ENCOURAGE OTHERS TO REPLICATE THE MODEL. ”

Ultimately we are working to demonstrate that:

The provision of:

- 📍 well located
- 👤 good quality
- 🏠 well designed accessible and adaptable housing
- 🔌 smart home technology; and
- 🌐 an independence enhancing support approach:

Results in:

- ↑ increased quality of life
- ↑ increased independence
- ↓ reduced life time care costs

FIRST TWO PROJECTS OVERVIEW

The Summer Foundation is developing demonstration projects in multi-storey apartment developments to provide the opportunity for greater independence and inclusion, compared to housing models that segregate housing for people with disabilities. The close proximity of apartments also provides some opportunities for efficiency in support provision.

In 2012 the Summer Foundation established a collaboration with Common Equity Housing Ltd and the Victorian Transport Accident Commission (TAC), Residential Independence Pty Ltd (RIPL) to establish the first of the housing demonstration projects. In this project there are six fully accessible self-contained one-bedroom apartments integrated into a 59 apartment mixed private and social housing development. The multi-storey, in-fill development is located in a prime inner city location in Melbourne, close to transport, shops and community facilities. The Summer Foundation purchased two of the apartments for the projects and TAC/RIPL purchased four apartments. Although construction of the apartments was well progressed when the apartments were purchased, apartments purchased could nevertheless be redesigned to be accessible. We have drawn on the learnings from this first demonstration project in the development of the second project in NSW.

In this second project the Summer Foundation has purchased ten fully accessible apartments for people with disability in the Hunter NDIS trial site. An additional apartment (ground floor) has been purchased to provide a base for support staff. These apartments are peppered through a five-storey mixed development combining ground floor retail and 110 residential apartments.

The ten accessible apartments, varied in size and layout, can provide housing for the target group detailed later in this section, living in a range of possible household circumstances. These include:

- Two ground floor apartments with direct street access from the apartment with one accessible bedroom and a second smaller room for example, for a study or friends staying over
- Six larger apartments with 2 bedrooms, including one with two fully accessible bedrooms; these are suitable for people living alone, with a family member, such as partner or child, or a friend
- Two large apartments with 3 bedrooms, creating the opportunity for people to live with a number of other family members if their current housing circumstances (for example lack of accessible design, lack of technology,) places them at significant risk of needing to move away from their important family supports

The remainder of this section focuses mainly on the Hunter Demonstration Project. Many of the apartment and common area features outlined were included in the Abbotsford project, but have been further refined, for improved accessibility and adaptability, in the second project.

2. HOUSING AND SUPPORT DEMONSTRATION PROJECTS



Apartment developments in which the two Demonstration Projects are located: Abbotsford (opposite) and the Hunter (above).

THE HUNTER TARGET GROUP

The prime target group for the Hunter Demonstration Project is people aged 21- 55 with acquired or late onset disabilities, in or at risk of entry to residential aged care facilities, who are seeking to develop their capacity for more independent living, and live either alone or with their family or a friend. The project is seeking to include participants with a range of disabilities including acquired brain injuries, spinal injuries and progressive neurological conditions such as Multiple Sclerosis. A number of tenants are anticipated to be people using large electric wheelchairs who have limitations in physical reach and strength.



Physical model indicating the context for the Hunter Demonstration Project, ground floor apartments with direct street access.



Both the Abbotsford and the Hunter projects are designed to support individuals using larger motorised wheelchairs.

GENERAL HOUSING FEATURES

The following sets out the housing related features of the Hunter Demonstration Project that are considered central to achievement of the desired outcomes for tenants.

Central location: The development is centrally located to public transport, services and the resources that tenants need for their daily living. This close proximity has the potential to reduce funded transport costs and support costs while enabling greater capacity to be more independent in daily living aspects such as shopping and going out.

Smart home technology: A range of smart home technology products have been incorporated both into common areas as well as individual apartments to maximise user independence. Technology to alert staff in the event of an emergency or the need for critical unplanned support is included in each apartment. Full home automation will be activated in two apartments, which will operate as temporary display apartments for six months. All other apartments will have built-in wiring and cabling that will enable cost effective future installation of home automation for tenants who receive NDIS funding for this to be installed.

General building accessibility features: The building has been designed to support easy movement for wheelchairs on key paths of travel from the project apartments (e.g. via automated common area doors). A generator backup is incorporated into the building services to ensure lifts operate for up to four hours in the event of a power outage and that essential communication and automation technology associated with the project continues to operate for at least four hours if power supply goes out. This covers most typical power outages and provides time for planning in the event of longer power outages. (Many of these features will also be of benefit to other tenants in the apartment building.)

Integrated and non-identifiable housing: Externally the project apartments are not distinguishable from other apartments. Their integration into the building provides opportunities for tenants to be part of the building community and establish relationships with neighbours.

Highly accessible and customisable design:

The intention is to provide a built environment, which maximises individual capacity and supports a person to do as much as they can independently, through accessible and customisable design. The Hunter Demonstration Project apartments have been designed to achieve Platinum level certification under Livable Housing Design Guidelines; plans for the apartments have already been awarded the Platinum Provisional Quality Mark, indicating high levels of accessibility. The design also supports adaptation in response to an individual's changing needs over time, as well as the needs of various tenants who may live in the apartment in the future.



SUPPORT MODEL FEATURES

The model under development is one of independent living in one's own home, with full tenancy rights, as well as responsibilities. The model incorporates a support approach that assists participants to develop their capability to live with as much independence as possible, encourages and facilitates in building a life that is personally meaningful and allows for engagement with others. To be successful, the support approach needs to encourage and support participants to make full use of the opportunities provided through the design and technology incorporated in the housing. The core elements of the support model are as follows.

Intensive transition and inclusion support

This focuses on supporting participants to set clear goals for life in their new home, based on their considered views about what they want to achieve. It also supports participants to build their capability in central aspects important to living more independently and in a sustainable manner, in line with their goals. The role of the person providing this support strongly focuses on proactive solution seeking and supporting tenants to strengthen their capabilities when challenges arise. This is a skilled and professional role, highly flexible and focused on supporting each person in a manner appropriate to his or her circumstances and aspirations. This role is a critical component of the support model for the first two years.

Individual support

Each tenant will receive individual supports funded in line with the goals of their individual plan. This funding is anticipated to predominantly come from the NDIS and will be varied for each person, based on their individual needs.

Access to 24 hour support to address emergencies and the need for essential unplanned support

The model includes access to 24-hour support in emergencies and when urgent unplanned assistance is required. At least in its initial phase this support includes 24-hour access to on site support staff. The options for addressing support requirements will be reviewed once all tenants have settled into their new homes and there is a clearer picture of the types of issues that lead to the need for unplanned assistance.

The methods for alerting staff include wall buttons, pendants or wrist watch alert devices, an alert button on a tablet or smart phone incorporated into the home automation technology, sending a text message, or making a call to the staff phone number.

A more developed role for support workers

An effective approach requires support workers to understand their role is more than providing practical support. An approach is needed that continues to support and encourage the tenant to direct their own life and build

their capability to do the things they have the capacity to do. This includes supporting people in using the technology and inbuilt design features, in order to benefit from these. It also involves supporting people to make the most of what the central location provides in terms of easy access to services, transport and recreation opportunities.

One support provider for all tenants for the first 2 years

One support provider will be engaged to provide support to tenants in the first two years of the project. Tenants will be involved in selecting the individual staff who will provide most of their personal support in line with their individual support plans. A process that allows for tenant involvement in reviewing the support provider arrangements beyond the first two years will be established.

“ AN APPROACH IS NEEDED THAT CONTINUES TO SUPPORT AND ENCOURAGE THE TENANT TO DIRECT THEIR OWN LIFE AND BUILD THEIR CAPACITY... ”

ACTION LEARNING AND FORMAL EVALUATION

In order to build robust and sustainable new models for a group in the community with high and complex support needs, we need the opportunity to progressively test and refine new approaches to design and support. Thus, an action research approach will underpin the early years of implementation of the Hunter Demonstration Project. This action research approach allows for refinement of the model, as new insights are developed into the effectiveness of specific practices, tenant capabilities, preferences and needs.

Formal evaluation is also central to the approach, in order to measure and systematically document impacts and outcomes of the model. A post occupancy evaluation will be undertaken, which will provide important feedback on the design and technology. A longitudinal evaluation to be implemented will provide insights into outcomes for individuals, as well as changes to their support requirements and support costs.



Summer Foundation formal evaluation and review process

3. KEY DESIGN FRAMEWORKS



In the Hunter Demonstration Project the Summer Foundation has purchased standard apartments “off the plan” well in advance of construction commencing. Early involvement in the design and construction process has allowed for the redesign of apartments so that they are suitable for people with significant disabilities.

There has also been some redesign, in collaboration with the developer, of a number of common area features to increase access and support incorporation of smart home technology features.

A number of considerations and frameworks have underpinned our approach to design and this section provides an overview of these. It outlines the core drivers for the approach to design, and two critical frameworks that have informed our design approach: namely the Universal Design Principles; and the Livable Housing Australia, Livable Housing Design Guidelines for Platinum level.

CORE OBJECTIVES

As indicated in the previous section, the demonstration projects being developed by the Summer Foundation have a very strong focus on:

-  **Supporting tenants to be as independent and included as possible**
-  **Supporting tenants have as much control over their home environment as possible**
-  **Providing a home environment that supports maintenance of family roles and contact with friends and family**

These three aspects have been key drivers for our approach to design, and are supported by the following objectives.

MAINSTREAM DESIGN FOCUS

Our objective has been to develop housing that, while being functional and accessible, looks and feels as much as possible like neighbouring apartments. To achieve this apartments have as many ordinary features as possible and there is use of mainstream, rather than disability specific design, products and equipment wherever possible.

CAPACITY FOR COST EFFECTIVE CUSTOMISATION

Housing for people with significant disabilities has to cater for both people with physical disabilities who often use large electric wheelchairs and people with cognitive disabilities, sensory disabilities and progressive changes in abilities and disabilities over time; some people live with a combination of these disabilities. Thus, in our design we have worked to incorporate cost effective and simple customisation and adaptation solutions that will enable simple modifications in response to the individual capacities and disabilities of the tenant/s living in the apartment.

POTENTIAL TO REDUCE SUPPORT COSTS

With the introduction of the NDIS and its insurance framework it is important to consider the way in which design, the products used, and the options available for individual customisation of features can contribute to savings in life time support costs. This framework has influenced the inclusion of a number of design features and our product selection.

SAFETY THROUGH A LENS OF SUPPORTING INDEPENDENCE AND CHOICE

Due to the particular disabilities and vulnerabilities of the project's target group, being able to live independently for some becomes a more likely possibility through attention to design aspects that provide options to address specific safety issues. Living options and design approaches for people with significant disabilities have often been restricted by a paternalistic focus on safety concerns. Thus, in order to respect the rights of people with disabilities to have dignity of risk, our approach has been to focus on design and features that support independence and choice about risks, rather than from a protective and limiting perspective.

SMART INVESTMENT

In selection of specific apartments and in the design there has also been consideration of long term potential to sell the apartments, or rent them out on a short or longer term basis in the private market in the event of unforeseen circumstances.

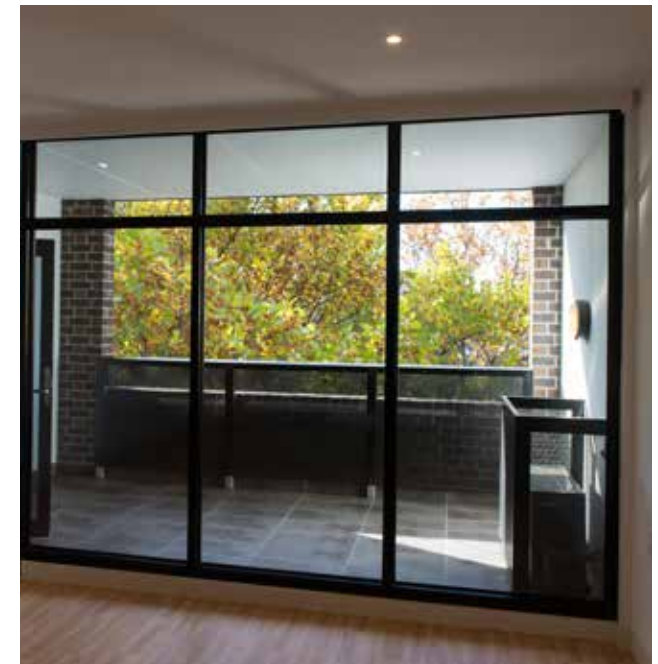

Project apartment, Abbotsford Housing Demonstration Project

UNIVERSAL DESIGN PRINCIPLES

Universal Design Principles have been a foundation for our approach to design.

Below are 3 excerpts from the Centre for Excellence in Universal Design website (<http://universaldesign.ie>), which explain these principles in more detail.

PRINCIPLE 1: EQUITABLE USE

The design is useful and marketable to people with diverse abilities.

PRINCIPLE 2: FLEXIBILITY IN USE

The design accommodates a wide range of individual preferences and abilities.

PRINCIPLE 3: SIMPLE AND INTUITIVE USE

Use of the design is easy to understand, regardless of the user's experience, knowledge, language skills, or current concentration level.

PRINCIPLE 4: PERCEPTIBLE INFORMATION

The design communicates necessary information effectively to the user, regardless of ambient conditions or the user's sensory abilities.

PRINCIPLE 5: TOLERANCE FOR ERROR

The design minimizes hazards and the adverse consequences of accidental or unintended actions.

PRINCIPLE 6: LOW PHYSICAL EFFORT

The design can be used efficiently and comfortably and with a minimum of fatigue.

PRINCIPLE 7: SIZE AND SPACE FOR APPROACH AND USE

Appropriate size and space is provided for approach, reach, manipulation, and use regardless of user's body size, posture, or mobility.

Universal Design is much more than just a new design trend

Universal Design is not a design style or trend. Rather, it is an approach to designing that can be applied to any design style or trend. It is an orientation to any design process that starts with considering the needs of the user. Fashion, style and personal taste can still influence the appearance of an accessible and usable product"

Universal Design is not just about 'one size fits all'

Universal Design has been mistakenly described as the search for a one-size-fits-all design. Universal Design does encourage designers to consider the wide-ranging abilities of their users. And where possible, an optimal design that caters for as many people as possible should be sought after. But a more universal solution can also incorporate, for example, customisable features that can be adapted from user to user, smart features that learn a user's preferences after multiple uses ... and specialised solutions to meet particular needs.

The aim is to provide the same (or equivalent) experiences, activities and services to everyone. It is accepted that these may have to be provided through slightly different routes or interfaces, but designers should strive to create a design that does not exclude or segregate.

Source: <http://universaldesign.ie/What-is-Universal-Design/The-10-things-to-know-about-UD/>

LIVABLE HOUSING DESIGN GUIDELINES

One of the design objectives for the Hunter Demonstration Project has been to achieve Livable Housing Design (LHD) Guidelines Platinum level rating. This design framework allows for flexibility in approach, while ensuring specific outcomes are achieved. To achieve certification requires assessment of the design during the documentation phase (i.e. via the plans) and at construction completion (via an on site inspection). The first part of this certification has been achieved.

The LHD Guidelines aim to improve the level of accessibility and adaptability of new housing so that the housing can meet the needs of a wide range of occupants across time. The LHD Guidelines has 16 core design elements; the core performance statement for each is outlined opposite (<http://www.livablehousingaustralia.org.au>).

There are three performance levels included in the LHD Guidelines - Silver, Gold and Platinum. Our 10 accessible apartments are being designed to comply with Platinum level requirements. This is the level that most accommodates ageing in place and people with higher mobility needs. This level requires more generous dimensions for most of the core livable design elements and introduces additional elements for features such as the living room and flooring.

CORE DESIGN ELEMENTS AND PERFORMANCE STATEMENTS

1. Dwelling access

There is at least one level step free entrance into the dwelling to enable home occupants to easily enter and exit the dwelling

2. Dwelling entrance

There is a safe, continuous pathway from the street entrance and/or parking area to a dwelling entrance that is level

3. Car parking

Where the parking space is part of the dwelling access it should allow a person to open their car doors fully & easily move around the vehicle

4. Internal doors and corridors

Internal doors and corridors facilitate comfortable and unimpeded movements between spaces

5. Toilet

The ground (or entry) level has a toilet to support easy access for home occupants and visitors

6. Shower

There is at least one level step free entrance into the dwelling to enable home occupants to easily enter and exit the dwelling

7. Reinforcement of bathroom and toilet walls

The bathroom and toilet walls are built to enable grab rails to be safely and economically installed at a future date

8. Internal stairways

Where installed, stairways are designed to reduce the likelihood of injury and also enable future adaptation

9. Kitchen

The kitchen space is designed to support ease of movement between benches and to support easy adaptation

10. Laundry

Laundry space is designed to increase circulation space between fixed benches, and to support easy adaptation

11. Ground (or entry) level bedroom space

There is space on the ground (or entry) level that can be used as a bedroom

12. Switches and power points

Light switches and power points are located at heights that are easy to reach for all home occupants

13. Door and tap hardware

Home occupants are able to easily and independently open and close doors and safely use tap hardware

14. Family/living space

The family/living room features clear space to enable the home occupant to move in and around the room with ease

15. Window sills

Window sills are installed at a height that enables home occupants to view the outdoor space from either a seated or standing position

16. Flooring

Floor covers are slip resistant to reduce the likelihood of slips, trips and falls in the home

BEYOND EXISTING STANDARDS

The Abbotsford Demonstration Project sharpened our understanding of how to balance the many factors that need to be considered in designing housing for people with significant disabilities. We continued to refine our design approach, taking account of insights from: formal evaluation; user feedback; other innovative design projects; and evolving practice wisdom amongst the individuals and organisations with whom we collaborate.

Compliance with a number of elements of the current AS 1428 suite of standards does not deliver a fully inclusive residential, home-like design in alignment with the core design objectives for our demonstration projects, outlined at the beginning of this section. We have recently initiated a project to systematically assess our design against AS 1428 Parts 1 and 2, which will document the specific elements where our design varies, as well as the reasons for this. This project is being undertaken in collaboration with the Transport Accident Commission/Residential Independence Pty Ltd and MSM Architects.

There is still work to be done in Australia on the design of medium and higher density apartment developments to ensure the availability of apartments that are more accessible and functional for people with significant disabilities. Incorporation of cost effective features that support easy and low cost customisation is also an area for further development. We believe that some of the design features of the Hunter Demonstration Project apartments, outlined in this report, move us further along the path to improved design.



PART 2 HOUSING DESIGN

DETAILED CONSIDERATIONS

Part 2 of this report sets out some of the specific design features, design considerations and learning developed through our projects. Part 2 has been developed to share in more detail some of what we have been learning and how we have considered or addressed particular issues.

We anticipate that parts of this section will need to be updated once tenants have moved in and we have had the opportunity to undertake a post occupancy evaluation.

- A. KEY DESIGN FEATURES | HUNTER PROJECT APARTMENTS
- B. COMMON AREA DESIGN FEATURES
- C. APARTMENT SELECTION CRITERIA
- D. KEY SPACES | DESIGN AND ADAPTABILITY FEATURES
- E. IDEAL PRODUCT FEATURES
- F. TECHNOLOGY
- G. LINKING INDIVIDUAL CAPACITY WITH BUILT ENVIRONMENT
- H. ASSISTIVE EQUIPMENT



A. KEY DESIGN FEATURES | THE HUNTER APARTMENTS

This section outlines a number of the specific design features of the Hunter Demonstration Project apartments developed to support the needs of people with significant disabilities. Several of these are further detailed in following sections of the report.

“... PEOPLE WITH SIGNIFICANT DISABILITIES CAN AND DO LIVE IN VARYING TYPES OF HOUSEHOLDS AND MAY HAVE ASPIRATIONS FOR FUTURE PARTNERING OR PERIODIC ACCESS TO THEIR CHILDREN.”

ALLOWING FOR REAL LIFE OPPORTUNITIES

The apartments have been designed to accommodate varying household types, as well as have the potential for resale in the event that the apartments in the longer term are no longer suitable. Sufficient space and amenities have been included in the apartments to support real life opportunities such as family (e.g. children or partner) or friends staying over or living with the person.

The 10 accessible apartments have either a second bathroom (eight) or at a minimum a second toilet (two). This ensures that the accessible bathroom in most instances does not need to be shared with visitors or other occupants. There are six apartments with a second bedroom, which may be used for a second permanent household member, or as a study, a place where family or children can come to stay over, or a place for additional

equipment. The two smaller apartments have a smaller space that can be closed off and used for a number of purposes. Two 3-bedroom apartments are designed to support families, in which one member has a significant disability, to live together in one space, particularly where access to affordable and highly accessible housing may support the family to remain together for longer.

While additional amenity and space may add to the purchase cost of apartments, they provide new housing opportunities, compared to residential aged care facilities and shared supported accommodation. The size and features of the apartments reflect the fact that people with significant disabilities can and do live in varying types of households and may have aspirations for future partnering or periodic access to their children.



Housing is designed to support a range of household types in the demonstration projects.

ACCESSIBILITY

A high level of accessibility is provided in the 10 project apartments, with each meeting the requirements for Livable Housing Design (LHD) Guidelines Platinum level certification.

Key features supporting accessibility

- Open-plan living, dining and kitchen
- Level flooring throughout, including into external areas
- Larger kitchen than standard non-project apartment kitchens, to provide improved access for people in wheelchairs e.g. capacity for a left or right sided approach

Accessibility features exceeding LHD Guidelines Platinum level requirements

- Wider doors, typically 950mm clear width, instead of 900mm clear width, to cater for larger wheelchairs
- Accessible wall-mounted power points located at 600mm, instead of 300mm high, to improve access for wheelchair users with limited reach
- Increased head height over car parking to allow for larger vehicles; 2.7m typically instead of 2.5m

Appliances and fittings | Features to support access and independent use

- Side-opening ovens with telescopic shelves for greater safety and ease of use
- Pull-out dishwasher drawer to support access
- Pull out pantry with open shelving for easy access from either side
- Induction cooktop to support ease of use and safety
- Pull out rubbish bin to support access
- Tap ware in the kitchen that is easier to use
- Shelving that can be lowered over the kitchen bench
- Sliding wardrobe doors for ease of access and use, and the ability to leave parts open or closed, depending on preferences for access and privacy
- Top hung wardrobe door tracks with flush floor guide to enable better access
- Wheelchair-friendly flooring (low-resistance) carpet in bedrooms
- Side-opening laundry tambour door to provide easy access to washing machine and dryer
- Pull down power points in kitchen to make power points not on an accessible side wall more accessible
- Control for exhaust fan located on front of kitchen joinery

Extent of accessibility

Project apartments are designed to be as accessible as possible, while considering cost and efficient use of space. For example, some storage is inaccessible; however, this may be suitable to store infrequently used items, or may be used by others living in the apartment. Where a building feature is inaccessible, an alternative option is provided elsewhere; i.e. a kitchen mobile island bench is a possible additional bench-top space if not enough of the fixed bench-top area is accessible for a particular individual.



Clockwise from top: rangehood control button, pull-down powerpoint, and side-opening oven with pull out tray below.

SUPPORTING DIGNITY

We have considered possible ways to provide the same level of dignity afforded to occupants in mainstream, non-disability housing to our project apartments. This is particularly important in areas where assistance through hoisting transfer may be needed.

Examples include:

- Providing a direct door from the accessible bedroom to the accessible bathroom, to provide privacy during hoist transfer from one space to another.
- No ceiling tracking is provided between bedroom and bathroom, to enable a more dignified manner of transfer. (Research undertaken by the TAC identified strong feedback indicating this as consumer preference.)
- Provision of privacy blinds in accessible bedrooms to shield a person being hoisted from outside view, while still allowing entry of natural light.



A direct link from the bedroom to bathroom provides privacy for a person who requires hoisting assistance, Abbotsford.

ADDITIONAL FEATURES

Provision has been made to enable the cost effective installation of several features, designed to support the increased independence of tenants. Key examples include:

- Power point has been provided at the toilet to enable installation of an auto flush sensor, for people who cannot reach the standard flush button
- Provisions have been made in the ceiling to enable installation of a hoist in the accessible bedroom and living area
- Power point has been provided to enable automation of the pull out pantry
- Power point in kitchen floor to enable power to be provided to an additional highly accessible kitchen island bench, for people in a reclined position in larger or customised wheelchairs
- Reinforcement has been provided in the wardrobe to enable grab rails to be installed

CUSTOMISABLE FEATURES FOR INDIVIDUAL NEEDS

Various apartment features have been designed to enable ready customisation in response to individual tenant needs, without high costs upfront, or in making the adaptations.

BATHROOM ADAPTABILITY FEATURES

- Reinforced bathroom walls in accessible bathrooms that allows for handrail supports to be wall-mounted in any position based on the needs of the tenant. In comparison to other disability housing design, handrails are not installed except when needed by the tenant.
- Flexible toilet setup allows for the toilet position to be moved to the left or right, and for the toilet type to be altered, to suit tenant needs, without any structural works. This is a key feature, due to the difficulty of moving toilets in apartment buildings.
- Bathroom basins on height adjustable brackets that allow changes in basin height
- Easy removal of bathroom cupboard doors to provide more accessible open shelving
- Shower screen that can be added or removed to suit individual mobility needs.

KITCHEN ADAPTABILITY FEATURES

- Capacity to adjust the height of the kitchen benches to suit the needs of specific tenants (height adjustment is through a change behind the kicker board), with specific design elements included ensuring the kitchen bench can be set at various heights. These are low cost approaches that require one visit by a tradesperson to adjust the height.
- Ability to remove under bench joinery to provide wheelchair clearance under the sink and cooktop and the ability to replace under-bench joinery if a specific tenant does not need the clearance.
- Ability to move the overhead shelving unit up or down.
- Power point in kitchen floor to enable power to be connected to any customised island bench needed by a tenant to support greater independence in the kitchen. (This is especially important for people in larger wheelchairs sitting in reclined positions who cannot fit under normal joinery.)
- Ability to remove and rotate the sink, to support better access and ability to use it (if space limits a multi-sided approach).

ACCESSIBLE BEDROOM ADAPTABILITY FEATURES

- Modular wardrobe joinery to enable easy rearrangement in response to individual client capabilities to access clothes.

HOME AUTOMATION TECHNOLOGY

Wiring (electrical and data) has been provided in each apartment to enable easy installation and programming of home automation technology in the future. The automation features are controllable within an apartment via a project-provided tablet, or a personal smart phone or other device, if needed by the tenant. Features that can be automated include:

- Apartment building entry door and door to individual apartment
- Apartment entry gates (applicable to five apartments only)
- Lighting
- Window blinds
- Operable windows
- Split system air conditioner, including temperature setting
- Building entry intercom and visitor access control
- Emergency call system

Two of the 10 apartments will have a number of features of the automation system fully installed and activated, to test the system, as well as demonstrate the system's capability. These two apartments will be used as temporary display apartments for the first six months.

Effective use of technology impacts in greater control and choice in day to day living (such as control over who is able to enter the apartment, and the ability to carry out everyday functions at any given time) and an increase in independence, through reductions in reliance on support staff.

The following examples demonstrate the impact of the home automation for someone who needs assistance with hoisting into bed.

- While in bed the person can open the main building entry door and apartment front door from the tablet to let a friend, their therapist, or tradesperson into the apartment without any assistance from support staff or family.
- A person in bed can determine when they turn their lights off or on, the desired temperature and length of time the heating or cooling is used. They can also decide when the blinds are opened or closed, independent of any staff support.

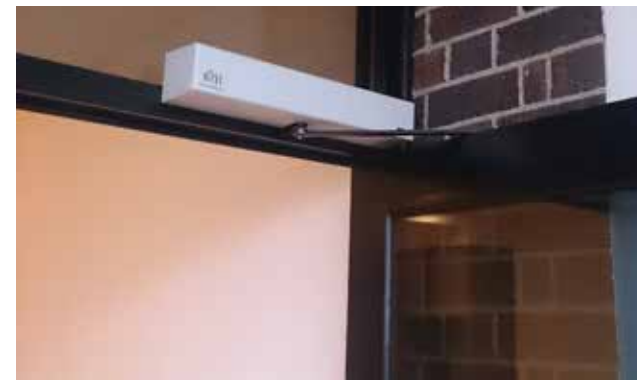

Automated apartment doors, showing internal wall button for automatic door opening (above), and typical door automation hardware (below), Abbotsford.

SAFETY FEATURES SUPPORTING INDEPENDENT LIVING

A number of features have been included to support the safety of tenants. These features recognise that some tenants will have disabilities and health conditions, which increase the need for communication, specifically the need to communicate quickly and effectively in the event of an emergency, or when unplanned support is needed. These safety features are outlined below.

EMERGENCY COMMUNICATION SYSTEM

- Tenants in all 10 apartments will be able to activate emergency alerts requesting communication with staff, through either a wall-mounted switch, pendant or wrist watch. In the event of having full or partial home automation installed in their apartment, they will be able to also use a button incorporated into the project-provided tablet for home automation.
- The apartments have two-way handsfree speakers and microphones on the ceiling in each main room of the apartment, to support quick communication with staff in the event that either an emergency alert is sent by a tenant, or a preset alert is triggered by sensors (e.g. temperature alert, water sensor alert).
- If using a tablet for managing home automation it is also possible to speak directly with staff through a tablet function when the person is in their apartment.

CAPACITY FOR SAFETY MONITORING AND ALERTS

Sensors in each apartment can be programmed to send an alert to support staff (if agreed that this is appropriate for a particular tenant) either to run constantly or in specific circumstances (for example when a person is unwell).

Alerts include:

- Room temperature alerts alert if the temperature in the apartment moves outside an agreed range for an individual tenant
- Movement sensor alerts if no movement has been detected in a certain location;
- Door opening monitoring e.g. to monitor whether a critical staff visit has been made to a person who is unwell
- Water sensor in shower alerts if shower water continues to run beyond a set time period (may assist in detecting falls or collapse in the shower)
- Water sensor alerts in case of flooding; the kitchen sensor is likely to be on for all apartments

Alert parameters are adjustable to suit an individual tenant and any changing needs over time and can be deactivated or activated as required.



Ceiling-mounted 2-way speakers (above) and wall-mounted emergency call buttons (below), Abbotsford.

FIRE SAFETY FEATURES

Detailed work on reasonable and cost effective augmentation to the building's fire systems has been undertaken with the support of a Fire Engineering Consultant, the building's fire services contractor and the builder's architect. Work has also been required to ensure streamlined programming between the fire services system and the emergency communication and home automation systems. Key features of the augmentations include:

- Replacing standard domestic smoke alarms with smoke detectors that automatically alert the Fire Brigade when activated under certain circumstances
- When a smoke detector in a project apartment is activated an alert is immediately sent to a staff phone indicating the apartment number
- When a smoke detector in an apartment is activated the automation system will turn on all lights in the apartment to assist in waking all occupants.

OTHER SAFETY FEATURES

- An additional air conditioner in accessible bedrooms ensures control of bedroom temperature for people who are sensitive to temperature, are in their bedroom for long periods of time and are reliant on staff to assist with getting out of bed
- Non-slip flooring in wet areas
- Hot water temperature control device (thermostatic mixing valve) is provided to enable infrequent adjustment to suit the tenant's sensitivity to temperature

MINIMISING FUTURE COST

Careful consideration has been given to maintenance costs and the cost for tradespersons to carry out tenant-specific customisations. The following outlines key specification examples to reduce future costs.

- Materials that are robust and resistant to damage, i.e. internal walls lined with 12mm FC sheet to reduce damage from wheelchairs and future need for repair works
- Slimline corner guards on those wall corners exposed to damage from wheelchairs, both in apartments and in selected common area corners
- Materials that are easy to care for, reducing specialist skills required for cleaning, such as timber-look vinyl
- Products that enable low-tech adaptability where possible, minimising the need for specialist tradespersons in future or the quantity of different trades required. For example, any person can adjust the bathroom basin height via manually-alterable brackets; wiring for future automated blinds is capped off with a visible power point on the wall, in order to be easily locatable in future, and not require patching up work.



Slimline wall corner guards and timber-look vinyl flooring, Abbotsford (left) and pre-wiring for future blind automation prior to install of coverplates, TAC RIPL Housing (right).

B. COMMON AREAS

Incorporating housing for people with significant disabilities in larger apartment developments provides an important new housing option for this group.

As Class 2 buildings under the Building Code of Australia (BCA), residential apartment developments already need to provide some accessibility features in common areas, which provide a base for augmentation as required.

These features include level entries, wider circulation spaces, door widths, signage and some accessible common area facilities. Apartment developments often also have building entry systems with security features that can improve tenant safety.

Careful assessment of an apartment development's common areas is needed to ensure functionality for people with significant disability. This includes attention to physical layout, corridor widths, accessibility and usability of the lift and technology, (including door automation), to ensure adequate access.

DESIGN ENHANCEMENTS

The table on the following page lists important common area design features in the Hunter Housing Demonstration Project, indicating those features that are standard for the building and those which have been requested as enhancements by the Summer Foundation. Enhancements most likely to impact on increased capital costs are highlighted in green.

Early involvement in these kinds of projects may provide the opportunity for negotiating cost-neutral enhancements, if these can increase the appeal of all apartments with little additional cost to the developer (i.e. radio-frequency controlled fobs used for locking are the standard method of unlocking doors in the Hunter Demonstration Project, and also allow for improved usability by people for whom physical keying is difficult).

Some enhancements will not incur capital costs, but will require increased design co-ordination with services (e.g. the position of ceiling-mounted ducting in car parking areas, to ensure adequate height clearances).

Most capital costs for additional requirements in common areas are due to requiring increased levels of accessibility and usability (i.e. automated common area doors, lift upgrades, generator back up and upgraded intercom).

Improved functionality contributes to a greater level of use for everyone (not just people with disabilities) at some stage of life, particularly older people, people with injuries, parents with prams, etc. The greatest scope to negotiate increased accessibility specifications may therefore be found in housing developments targeted to include a wide demographic base, where these features are recognised as adding value for many residents in the building.



Artist's impression of the accessible central landscaped courtyard; apartment development incorporating the Hunter Demonstration Project.



HUNTER DEMONSTRATION COMMON AREA DESIGN FEATURES

	BASE BUILDING DESIGN FEATURE		ENHANCEMENT	
	No additional costs (standard feature)	Minimal Capital Cost implication (or design co-ordination required only)	Major Capital Cost Implications to Consider	
Accessibility	Flush-level building entries	Minimal number of doors on common access paths	Automated doors on all paths of travel to project apartments and neighbouring apartments	
	Typically 1600mm wide corridors with minimum (1200 mm wide where a 1600mm turning circle is provided)	Automated common area door widths min 900 mm clear	Capacity for wifi /radio frequency control of lift, through hand-held device if a person can't safely use lift buttons inside or outside the lift (cost of wifi access point, RF wiring + hand-held device)	
	Radio-frequency access fob to open building entry door, unit door and garage door either by swiping or remote control	Lift buttons and door centrally located to maximise accessibility	Capacity to use intercom via a hand-held device if a person can't operate the intercom buttons.	
		Letterboxes located at accessible height (between 700mm and 1100mm)	Letterbox control via radio-frequency if a person cannot use a physical key for unlocking	
Supporting safety when living independently	Secured building access (secure access fobs and intercom)		Power backup for lift and essential services in project apartments for up to 4 hours	
Amenity	Covered taxi-drop-off area in underground carpark	10 accessible parking spaces (1 per unit) - upgrade of car park type needed		
	Basement cage storage (1 per unit) approx. 5m ³ (cubic m)	Min. 2.7m head height over car spaces to allow for a van, one car space with 3m head height to allow for a van with equipment stacked above		
	Accessible ground floor café	Accessible bin chute		
	Accessible lounge on LO1 for recreational use, with toilet	Accessible single public car space on Ernest Street (option to be negotiated with local council)		
	Accessible central landscaped courtyard			
Durability	Concrete walls (less prone to damage from wheelchairs)	Slimline corner guards to wall corners most vulnerable to damage		

ANCILLARY FEATURES AND FACILITIES

Apartment developments today may incorporate a range of other functions, to further the appeal and amenity of the overall development. These may include health and fitness facilities (such as gym, pool, etc.), cinemas or lounge spaces. Mixed-use apartment developments may integrate community facilities such as gardens, workshop facilities, libraries or playgrounds.

Such facilities may be particularly valuable for people with disability, as these can increase opportunities to form social relationships, develop new skills, as well as reduce travel time and costs associated with accessing (potentially supported) services off site.

It is particularly important that these ancillary spaces achieve a non-institutional look, and that functional requirements are integrated in ways that are attractive and seamless with the building design, to maintain appeal to the broader market.

Some examples of functional challenges when designing for independence and possible design techniques in these ancillary spaces are provided as examples, here.

	DESIGN ISSUE	FUNCTIONAL RESPONSE	EXAMPLE OF DESIGN TECHNIQUE
1	Reduced cognitive ability / memory	Simple way-finding and good visual connectivity to the rest of the development	Clear signage, building layout (openness) or building materials (transparency)
2	Population with broad range of sensory / cognitive abilities and preferences, and preference for these to co-exist, for social inclusion	Range of zones provided which can be used differently, at the same time, with options to create privacy between zones, if desired	Options for open and intimate areas in a café (e.g. to enable louder or quieter activities), combination of paved and soft ground surfaces in outdoor spaces to encourage use by all (i.e. whether using a wheelchair, or not)
3	Assistive technology, equipment and devices may be needed to enable use	Consider adapting the built environment to incorporate the assistive function	Design of pool areas can support a person who uses a mobility aid to independently transfer in and out, via incorporating a portion with a raised upstand.

C. APARTMENT SELECTION CRITERIA

Early feasibility studies in the Hunter Demonstration Project considered which apartments may be most suitable for use as project apartments, including attention to quantity, size, location within the development.

Due to the early involvement in the project and flexibility of the developer-builder, the opportunity was available to make various modifications to apartment footprints where necessary to achieve units of sufficient size and appropriate shape for our project's requirements.

Considerations and specific principles for apartment selection are outlined opposite.

FLOOR LEVELS

- Preference to provide some ground floor apartments, as an option for tenants with increased need for easy access and egress (i.e. without relying on a lift)
- Preference for apartments to be located over a range of floor levels, to offer varied living options, encourage interaction opportunities with neighbours, as well as independence from other project tenants and support staff
- Apartments located above each other with the same unit footprint will cut down on design time and simplify building services



Two units are located on the ground floor with direct access from street level, artists impression, Hunter Demonstration Project.

SHAPE

- Preference for square-proportioned apartments which enable open plan living (and flexible use of space)
- Avoid external or internal articulation that may make space less accessible for wheelchair users
- Straight access paths from lift to apartment, with minimal turns will be easiest for wheelchair users
- Simple access paths from lift to apartment, with minimal turns will be easiest for tenants with cognitive issues

ENVIRONMENT

People with disability may at times experience physical limitations, which make activity in the community difficult and potentially increase time spent at home. Some may at times experience an increased sensitivity to heat, noise or light. Ideally apartment design supports mental and physical health. Standard apartment amenity features that support a healthy environment include the following:

- Access to daylight
- Controlled access to external views and stimuli
- Privacy from sources of loud noise (i.e. traffic, machinery)
- Option for natural ventilation

Corner positions may offer more scope for daylight and natural ventilation, but increased amenity is likely to increase the apartment purchase price.

APARTMENT SIZE

Two bedroom

Assessment of accessible apartment design in other projects suggests most demand for two bedroom apartments, with a minimum of 85 square metres.

- Larger apartments are needed to achieve Platinum rating under the Livable Housing Design Guidelines - this certification allows for an apartment with spaces of varying accessibility; i.e. second bedrooms and second bathrooms are not assessed, ideally these spaces are as accessible as possible
- Sufficient circulation space is required to suit a motorized wheelchair user (larger space requirement than for a manual wheelchair user)

These apartments would have:

- One fully accessible bedroom and bathroom
- A second bedroom of at least nine square metres
- A second small non accessible bathroom
- A kitchen of sufficient size to be functional for people in larger electric wheelchairs

One and a half bedroom

Smaller 1.5 bedroom apartments need to be a minimum of approximately 70 square metres. These apartments would have:

- One fully accessible bedroom and bathroom
- A second multi use space that can be closed off from other areas for use as a study, place for visitors to sleep, access visits by children, or carer sleepover in event of temporary serious illness or incapacity
- A separate second non accessible toilet (with small hand basin)
- A kitchen of sufficient size to be functional for people in larger electric wheelchairs

Three bedroom apartments for families

A small number of these apartments would be required compared to the 2 and 1.5 bedroom apartments. The minimum size would be around 100 square metres.

These units would have:

- A fully accessible bedroom and bathroom
- Two bedrooms of at least nine square metres
- A separate full bathroom with shower and toilet
- Design that provides some capacity for zoning
- A kitchen of sufficient size to enable a person in an electric wheelchair to use at least part of the kitchen

PRIVATE OUTDOOR SPACE

- Private outdoor space is preferably low-maintenance; larger areas require more maintenance
- Balconies may be preferred to large landscaped areas due to reduced maintenance requirements
- Square-shaped outdoor spaces are preferable to long narrow balconies, which restrict easy wheelchair movement

OTHER CONSIDERATIONS

- Zones of extended habitation ideally provide an outlook
- Capacity to view TV and entry door simultaneously is beneficial, as this allows for a sense of security and control
- Ideally there are areas where staff do not go to provide support e.g. such as living space which is able to be zoned off (i.e. either through apartment or furniture layout) to provide a sense of private space
- Minimum indentations to room is preferable to minimise obstructions for wheelchair users and maintenance issues
- Adequate space provisions are needed for accessible storage

HUNTER DEMONSTRATION PROJECT FLOOR PLANS

These diagrams demonstrate key space provisions and spatial relationships, considered during early feasibility studies. These reflect the Apartment Selection Criteria, and can be summarised through the following principles:

INTERNAL LAYOUT GENERAL PRINCIPLES

- External window to Platinum Bedroom
- Direct access to Platinum Bathroom from both Accessible Bedroom and Living
- Rectangular open plan Living / Dining / Kitchen
- Non-accessible second Bathroom / Toilet
- At least one second Bedroom (with either internal or external window)

FLOOR PLAN KEY

Platinum Bedroom

Platinum Bathroom

Living / Dining / Kitchen

Second Bathroom / Toilet

Second Bedroom

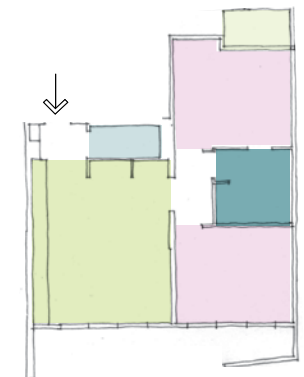
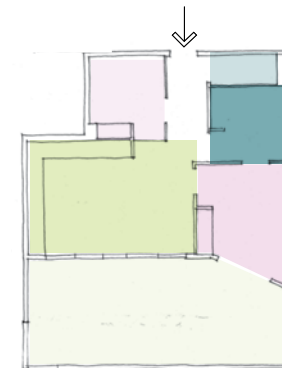

SEE APPENDIX 1

D. KEY SPACES | DESIGN AND ADAPTABILITY FEATURES

This section presents design considerations and challenges for key spaces in an apartment: the living area, accessible bedroom, kitchen and accessible bathroom. These insights focus on the goal to support tenants in achieving maximum independence over their home environment.

Significant time and thought has been invested in developing the design to support this focus, including reflections on our Abbotsford Demonstration Project. A key consideration has been how to design apartments in the absence of details on tenant-specific disabilities and capacities, at the time of design and construction.

ABBOTSFORD PROJECT LEARNINGS

These apartments were developed to have a number of accessibility features; full integration of these features was limited due to the progressed state of construction when the Summer Foundation purchased the project apartments. A number of individual modifications to the completed apartments were needed for 2 specific tenants. Further adaptations and adjustments were necessary for these individuals post tenant move-in; these adjustments have been a key source of learning that has informed our second project. Diagrams are provided to outline these necessary adaptations, along with commentary on the insights developed through this process.

DETAIL ON PG. 38

ACCESSIBLE BATHROOMS

Key design features and considerations in the design of Accessible Bathrooms are outlined in this section. These focus on necessary factors to achieve accessible and functional bathrooms, that are also aesthetically pleasing, and can have features cost effectively customised for tenants, when the basic design does not support their potential for greatest independence.

We consider the flexible toilet design in particular to be an important design innovation for apartment developments, where it is difficult to change plumbing locations. This design provides considerable flexibility in location and type of toilet, and allows cost effective customisation of the toilet configuration for an individual person. The ability to easily adjust the height of the vanity basin is another important feature, as is the ability to fold back shower screens, or easily add or remove a glass panel.

DETAIL ON PG. 46

KITCHENS

This section presents a number of insights into kitchen design considerations, drawing on work across a small number of housing projects for people with significant disabilities. The design is aimed at supporting greater opportunities for people in larger wheelchairs to do as much as possible for themselves in the kitchen. Both design and product selection play an important role in achieving this.

An example is included here, to illustrate how features and products can support someone using a large wheelchair with limited hand function in lunch preparation at any desired time, without requiring access to staff support at the time. The ability to do this provides the person with greater choice about when and what they eat, while at the same time reducing the cost of their support through not requiring support staff assistance at lunch time.

DETAIL ON PG. 53

TASK	DESIGN, FIT OUT AND PRODUCTS TO SUPPORT THIS
Independently take a prepared meal from their fridge	<ul style="list-style-type: none"> • Sufficient circulation space near fridge • Accessible location and preferred door opening direction so fridge can be opened by the person in the direction that best suits their strengths • A fridge that is of the right dimensions and configuration so that the person can reach and take out either a meal on the shelves or in the freezer (e.g. fridge model with a freezer drawer at the bottom may be preferred)
Put the meal in the microwave	<ul style="list-style-type: none"> • Sufficient circulation space to move between fridge and microwave • Attention to placement (including height and accessible approach) of microwave to be reachable by the person • A microwave that the person can open and manage use of the controls
Put dirty plates in dishwasher	<ul style="list-style-type: none"> • Sufficient circulation space to be able to open dishwasher and place plate in it • Dishwasher model type and dimensions, that the person can open and close, easily reach and control functions • Attention to placement at accessible height, to reduce reach needed

ACCESSIBLE BEDROOMS

While design of bedrooms and bedroom storage is generally less challenging than kitchens and bathrooms, a number of important aspects need to be taken into account, to ensure that the layout and features support this being a functional, as well as comfortable space. The diagrams and photos in this section again draw on insights from a number of projects.

DETAIL ON PG. 63

PRIVATE OUTDOOR AREAS

Private outdoor areas, if well designed and accessible, are important extensions of indoor areas. In the Hunter Demonstration Project all apartments have direct access to private outdoor balconies or garden areas. There have been both opportunities and challenges in the design of some of these areas; specifically the design needs to be considered together with the placement and type of external windows and doors to support good overall use and accessibility. A number of diagrams documenting the principles underpinning our approach are included, along with some of the insights arising from this work.

DETAIL ON PG. 66

OTHER SPACES AND PROVISIONS

The final part in this section provides some comments on entries, laundries, second bedrooms, second bathrooms / powder rooms and storage.

DETAIL ON PG. 68

ABBOTSFORD PROJECT LEARNINGS

DESIGN ISSUES AND BUILDING MODIFICATIONS

LARGE APARTMENT

A number of features of these apartments are a result of design involvement that began midway during construction. Internal spaces needed to work with existing structural walls and plumbing points. This resulted in some access challenges but also inspired some design ideas. A number of modifications were needed in the two apartments to allow best use for the two individual occupants.

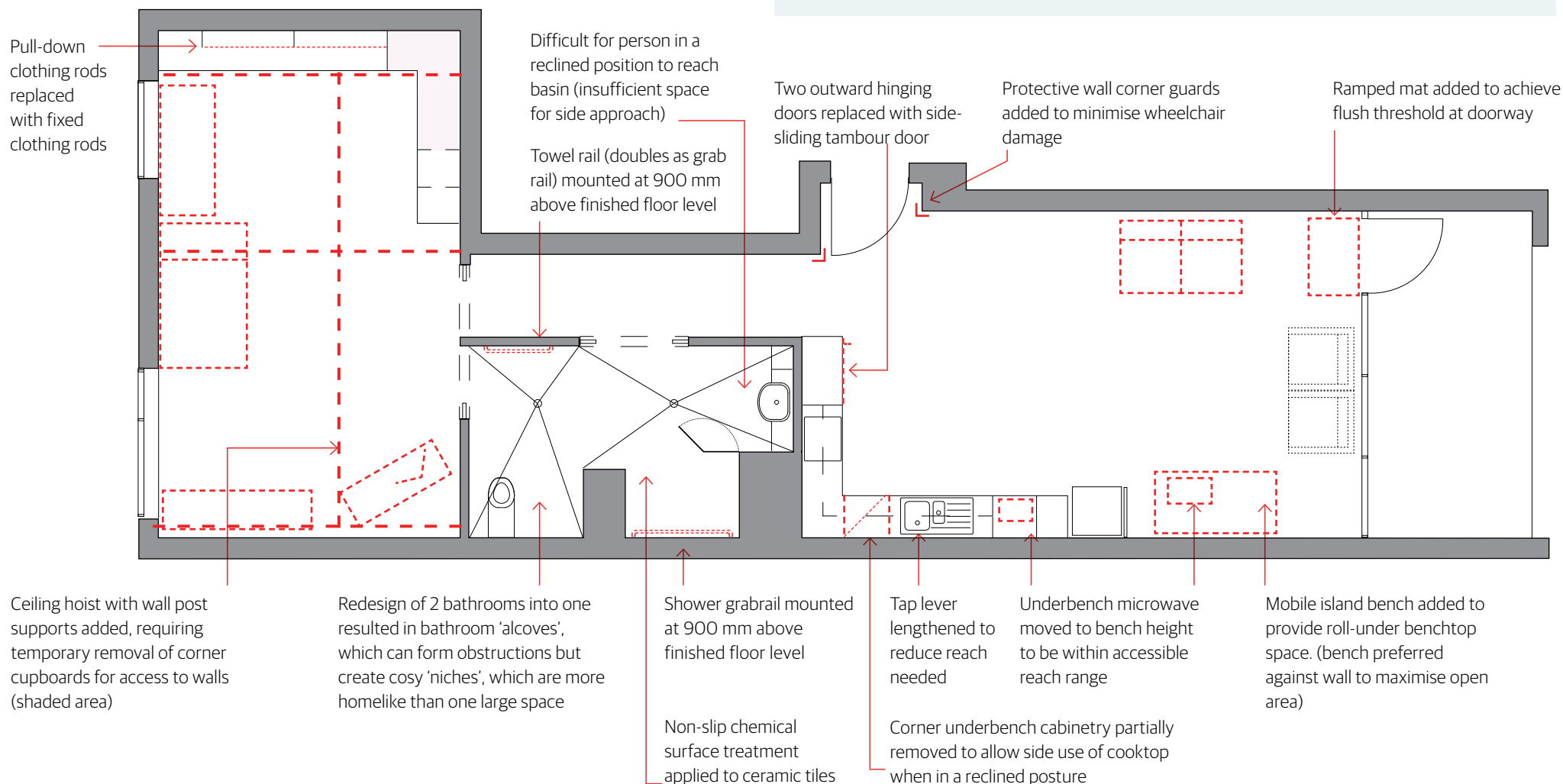

SMALL APARTMENT

Hole made in tower cabinet to allow power cord extension (from washing machine powerpoint) for use of hairdryer at basin.

Underbench cabinetry removed below induction cooktop to allow underbench knee clearance for wheelchair user.

High-level microwave moved to low-level, below induction cooktop (suits user's profile and reach).

Mobile island bench added to provide additional benchtop space and storage (overhead cupboards too high).

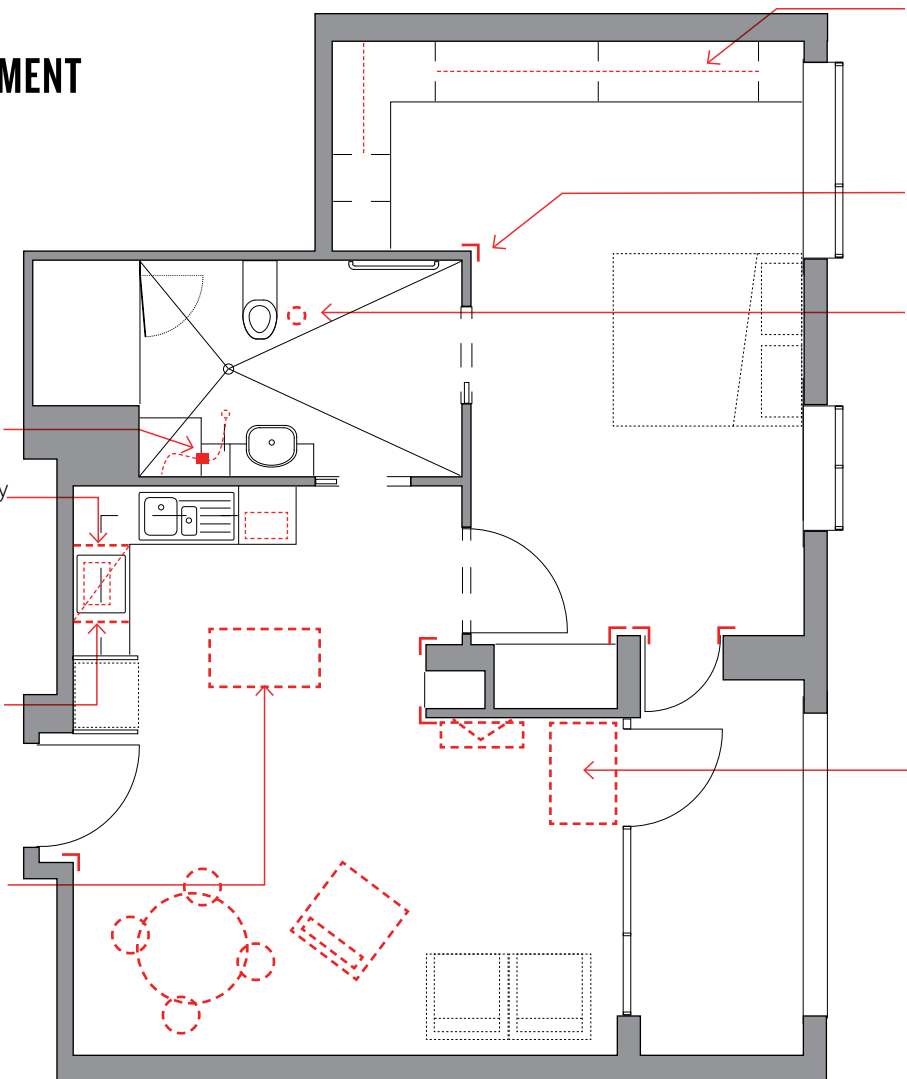

Pull-down clothing rods replaced with fixed clothing rods, additional clothing rods added at low level.

Protective wall corner guards added.

Mobile toilet roll holder added to improve access and reduce difficult twisting motion.

Ramped mat added for a flush threshold at doorway.



Bathroom vertical tower cabinet (left) with hole added for use of appliances at basin (right)

BATHROOMS AND TOILETS

difficult for person in a reclined position to reach basin (insufficient space for side approach)

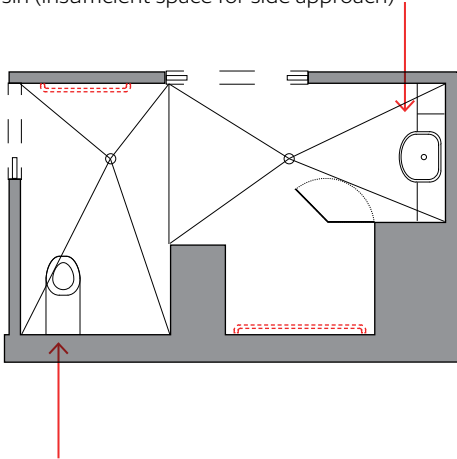

fixed toilet position wouldn't allow for side transfer from the left

FIXED TOILET LOCATION IS PROBLEMATIC

A fixed toilet position that is located to one side may reduce independence for a user who relies on uses one particular side to transfer onto the toilet. Adequate space, or flexibility to move the toilet is needed, to promote maximum opportunities for self-transfer.

Flush buttons mounted to the rear wall can be difficult to use, for users with limited reach and limited twisting capacity. Automatic flushing triggered by sensors may be useful in this situation.

DDA-COMPLIANT TOILET IS NOT ALWAYS NEEDED

In-wall cisterns with an extender piece were installed, for a 'visually clean' look, while achieving the depth of a DDA-compliant toilet. (A longer, DDA-compliant toilet allows for a mobile shower commode to be wheeled over the top.)

However the additional pan length may not be needed by a person who self-transfers, and may make access to the buttons and toilet roll holder difficult for a person with limited reach.

BUILDING FABRIC DOESN'T ALLOW FOR TOILET FLEXIBILITY

The in-wall cistern does not allow for relocation of the toilet. The toilet plumbing connection in the wall is not flexible; additional pipes would be needed to connect to a new toilet location, which would need to be boxed in by a cabinet maker. A new toilet would be needed, as well as three tradesmen; to re-plumb, re-tile, and form up cabinetry around exposed piping.

CAN BE DIFFICULT TO MATCH FUTURE PARTS

Installing a standard concealed cistern toilet, with the intention to add an extender piece in the future if needed, may be problematic if matching accessories are no longer available. Replacing a standard exposed cistern toilet with a DDA-compliant toilet with exposed cistern removes the need to match parts in the future.



Abbotsford Bathrooms; showing fixed toilet locations; with extended piece, and basin (below).



person with small stature cannot see themselves in the mirror and basin height is fixed

metal basin trap can scald bare legs

EXPLANATORY NOTES

TOILET ACCESS REQUIREMENTS

Acquired neurological injury results in physical impairments, which may include paralysis of one side of the body or, "hemiplegia".

Reduced mobility may require use of a mobility device, such as a wheelchair, a mobile shower commode, or over-toilet commode.

For people who self propel their mobility device, there need to be options to transfer from either side of the toilet.

A longer toilet pan ("DDA-compliant") may be needed to allow use of a tilting commode chair.



Example of a tilting shower commode, which may be used to roll and tilt over a toilet pan, from LifeMobility.

APARTMENT CONSTRUCTION

Concrete construction used in apartment type buildings poses challenges to moving plumbed services due to the fixed plumbing points in walls and floors.

Relocation of services will generally require the addition of unsightly plumbing from the existing waste point to the new inlet. New exposed plumbing may be concealed within cabinetry if budget permits.

KITCHENS

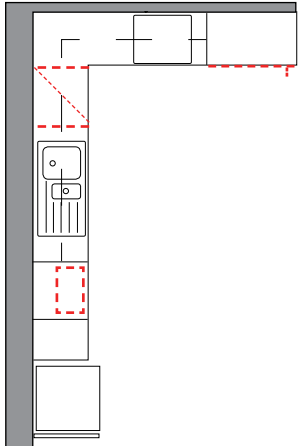

KITCHEN CORNERS

We noted that access to the induction cooktop was difficult for a person in a large motorised wheelchair with a reclined posture, particularly if relying on using their right hand side for cooking. Corner underbench cabinetry was removed to provide access for legs, enabling side access to the induction cooktop.

Provision had been made to enable removal of cabinetry below the cooktop, however its removal would not improve access for a user with reclined posture.

Complete removal of corner underbench cabinetry for increased access was limited by the need to retain some panels for structural support of the benchtop. Hence corner underbench cabinetry was partially removed only, to enable use of the cooktop for this user.

This modification work suits one particular user's physical requirements. However a different person may require underbench access below the cooktop only or require no underbench access at all. Having a range of options to alter corners can be useful in balancing individual access and the accessible storage needs.



Large kitchen, Abbotsford, prior to individual modifications

Post individual modifications, corner underbench cupboard removed to allow use of the cooktop by a person with reclined posture.

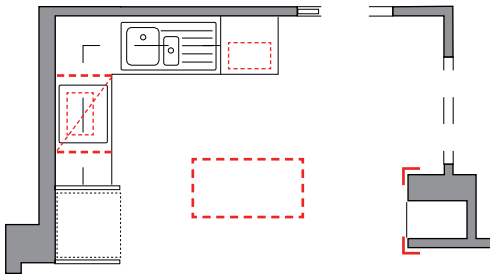

REMOVABLE UNDERBENCH CABINETRY – SINKS AND COOKTOPS

Cabinetry below sinks and cooktops was designed to be removable, to provide basic underbench knee clearance for a seated user. We noted the importance of the following details:

- Wall surfaces need to be adequately finished behind removable cabinetry.
- Removal should be simple and possible by one person (lightweight materials and use of wheel bases may be useful in this regard).
- No services should be located behind the removable cabinetry that need to be accessed on a regular basis (e.g. powerpoints for dishwasher), which would prohibit use if cabinetry is in place.



Removed underbench cabinetry post tenant modifications, Abbotsford



Underbench knee clearance and continuous flooring, kitchen, TAC RIPL housing.

MOBILE ISLAND BENCHES

Height-adjustable mobile island benches were added to TAC apartments to provide additional roll-under benchspace, particularly for users in larger motorised wheelchairs and reclined positions. Design feedback indicated:

- low-level lateral bracing prevents access from one side
- larger sized benches need to be welded otherwise they may sag over time
- a lighter weight bench is easier to move for tenants or support staff (fixed storage will add to the weight)

Opposite: Towel rails can be used as easy-to-reach hanging space.



Lower-height shelving is not accessible for most users in larger motorised wheelchairs and adds to weight of unit.



A bracing panel can form an obstruction for some users.

Through developing the design in Summer Foundation units, we learnt that island benches when kept as small as possible minimise the amount of space taken up within the kitchen area, supporting freer movement.

We noted that island bench surfaces need to be robust to withstand daily use (e.g. toughened edges are needed to prevent chipping).

BEDROOM BUILT-IN-ROBES

In the Abbotsford project we noted the following points:

- Pull-down clothes storage systems required too much arm strength to pull and hold down at an accessible height for most users.
- Open display is very useful for easy access but does not allow for privacy of personal items.
- High-level storage areas could be used for storage of infrequently used items, to maximise use of space, particularly in smaller apartments.
- Soft-close drawers can be difficult to operate when empty, but wire baskets are useful for viewing contents and prompting memory.
- Siliconing cabinetry in place can make future alterations time-consuming, requiring removal of silicone and repainting by hand (to minimise surface damage).
- Difficult for those in larger motorised wheelchairs to access corner storage, hence ideally corners are minimised.
- It is difficult for those with limited reach to access high level storage, hence height is ideally flexible.
- Walls posts can make the room more visually busy than a standard apartment.



Hanging space enables more independent access to clothes store for one user than shelving (opposite). Additional hanging rods were installed at a lower height to suit the user, who uses a small manual wheelchair.

We noted that standard white internal carcasses are useful where modifications may occur, as it is easier to colour-match patches, silicone, etc.

Above: Large Bedroom, Abbotsford, with pull-down clothing rods prior to individual modifications

Opposite: Small Bedroom, Abbotsford, post individual modifications

ACCESSIBLE BATHROOMS

LHD PLATINUM REQUIREMENTS

Either a lever or D-pull handle needed (minimising the thickness of the handle and omitting a handle fixing-plate can help to create a less institutional look)

level flooring transitions

minimum 1200 wide 'corridor'

12mm ply sheeting or concrete walls to shower and toilet to enable easy future addition of grabrails

step-free shower with minimum dimensions of 1160 x 1100mm

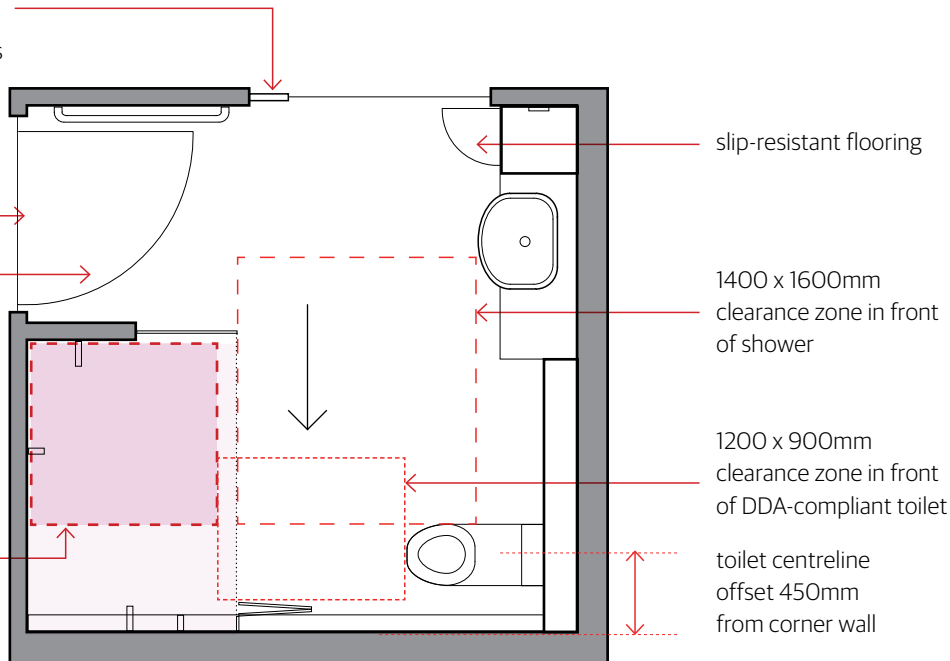

D-pull handle, required to achieve platinum level.

LHD DESIGN "RULINGS"

Where a design does not meet the LHA Platinum requirements technically, but meets the intentions of an objective, LHA may make a ruling that allows for the alternative design.

For example, in some apartments the toilet may be installed in a location other than the corner for increased usability, however the flexible toilet design allows for a toilet to be returned to this position if needed.

CUSTOMISATION OF FITTINGS

For fixtures and fittings to be most usable by an individual, these items will not be fixed until the tenant is known for each apartment and their specific access needs are identified (i.e. toilet roller holder, towel rail, clothing hook, etc). This is intended to save potential alteration works required in the future to wall linings.

We have sought to use removable fittings where possible. E.g. the location of a suction-cap shower shelf can be more easily customised to a user than a fixed shelf.

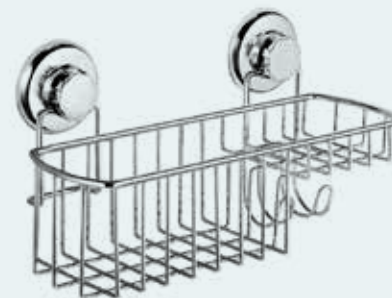

Suction-cap shower shelf

ADDITIONAL DESIGN CONSIDERATIONS

towel rail (behind door) doubles as grab-rail

higher level of slip-resistance to tiles (BPN 45 'W' rating) to increase safety

single floor slope and strip drain for safety (less trip hazards), easier for wheelchair user to control movement, provides mainstream look

removable showerscreen to increase circulation area if required (i.e. for a mobility device)

separate shower niche for a non-institutional look

waterflow sensor to alert staff of potential falls

two shower heads provided - second shower head allows for the body to be kept warm while washing the head - second shower mixer is located for easier use by someone assisting

larger shower for increased usability and mainstream appeal (i.e. space for 2 shower heads)

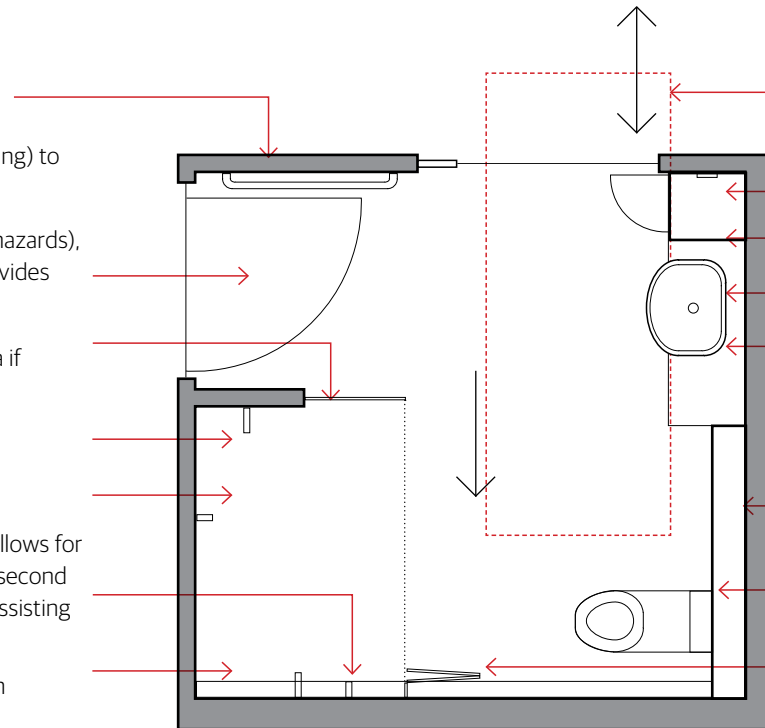

direct link to living area and accessible bedroom, to enable use as a shared bathroom or private ensuite. Privacy snibs are needed to allow dual use.

position of door allows for a left or right sided approach to basin and storage, sliding door allows for easier reach of the handle than a hinged door

side-mounted powerpoint for easier access

flexible display vertical cupboard

task lighting to increase safety at basin

height-adjustable semi-recessed vanity with underbench knee clearance

12mm ply sheeting or concrete walls throughout to enable future install of grabrails

powerpoint provided for install of sensor autoflush if flush button is not reachable

flexible toilet location and type

foldable showerscreen to increase circulation space in front of toilet or in and out of shower

ENVIRONMENTAL CONTROL AND COMFORT

People with aquired brain injury and spinal chord injury, are less able to regulate body temperature due to neurological impairment.

Hence optional amenity features (such as air conditioning or ceiling heat lamps) in standard apartment developments are more necessary in apartments for this group.

HOMELIKE LOOK

The base building colour scheme is maintained in the Summer Foundation bathrooms, for a mainstream appearance.

Standard bathroom, Hunter apartment development



FLEXIBLE TOILET

FLEXIBLE LOCATION

Toilets in Accessible Bathrooms can be located in 3 different positions, to suit an individual user's preferred side of transfer.

This feature is designed to maximise the opportunity for independent self-transfer, reducing the potential need for installation of grabrails and support staff assistance.

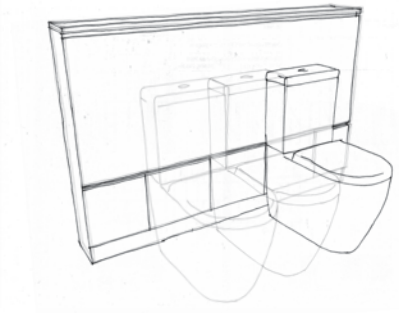

Position 1 - standard location as per LHD Platinum requirements (left-sided transfer)



Position 2 - alternative central location

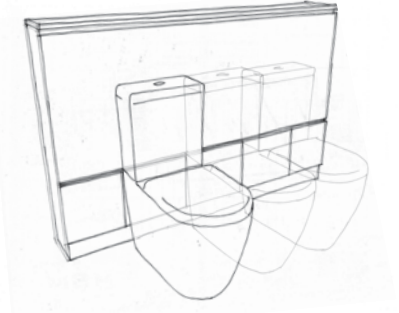

Position 3 - alternative location for right-sided transfer

FLEXIBLE TOILET TYPE

Any toilet with a P-trap (rear waste point) with a similar setout point may be installed, including either a standard toilet (approx. RRP of \$300) or a DDA-compliant toilet (approx. RRP of \$2400). Hence this design feature can save the cost of purchasing a DDA-compliant toilet, if it is not needed.

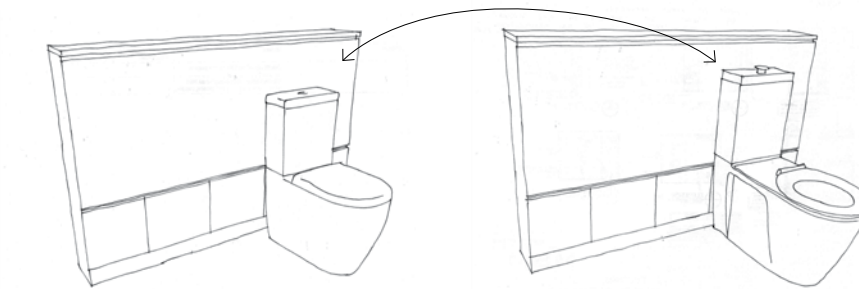

A standard toilet and DDA-compliant toilet can be easily and cost-effectively swapped in future if necessary.

HOW THE FLEXIBLE TOILET WORKS

A space for plumbing to be adjusted in a concealed space is provided in a mid-height wall.

If included during the design phase, such a design feature can be integrated into the bathroom's aesthetic without large cost.

EXAMPLE OF RE-POSITIONED TOILET > FROM AS-BUILT POSITION

Half-height wall provides a shallow shelf for easy access to everyday items.

Fixing zone allows for installation of grabrails between 700 and 900mm above finished floor level.

Toilet sits on tiling, allowing re-positioning without damage to the floor surface.

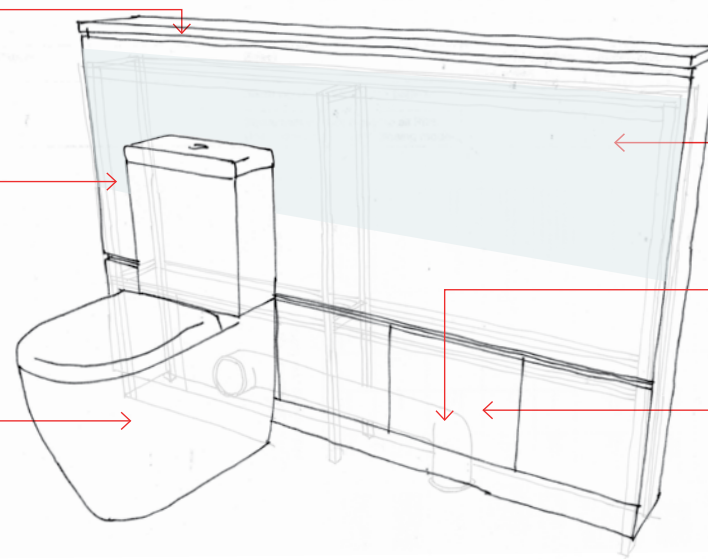

Steel frame and ply sheeting allow for retrofit of drop-down grabrails, if required (to support weight of at least 112kg).

Alterations to PVC plumbing pipes are concealed within the nib wall.

3 centre modular panels on simple lift-off battens provide access to piping, and can be re-arranged to suit the preferred toilet location.

CAPITAL COSTS TO PLAN FOR:

➔ supply & install of wall \$950 - \$1200

CUSTOMISATION COSTS TO PLAN FOR:

➔ supply new toilet
 standard toilet = approx. \$300 ex. GST
 DDA-compliant toilet = approx. \$2400 ex. GST

➔ labour to re-position toilet (estimate 1 hour)
 = approx. \$150 + call out fee approx. \$100

➔ No joinery costs

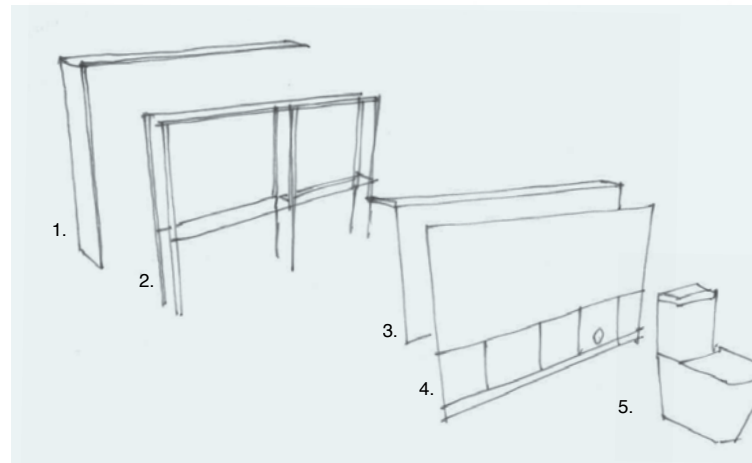

PHYSICAL COMPONENTS

1. laminate panels
2. 20x20 SHS steel frame
3. 12mm ply sheeting
4. laminate panels
5. toilet

HEIGHT-ADJUSTABLE VANITY

The bathroom basin is height-adjustable to better suit an individual's posture and size, making it easier to carry out tasks independently.

Height-adjustable brackets are a once-off cost, which any handy person can alter, using a spanner to loosen a screw on each bracket.

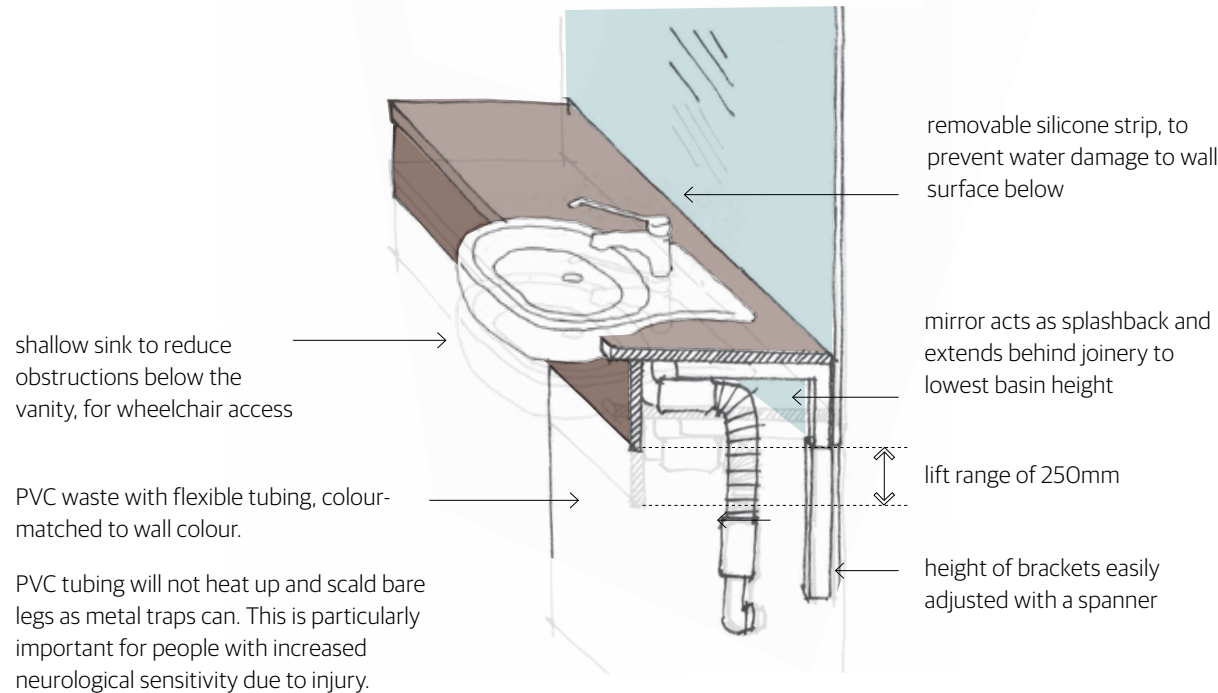

ALTERNATIVE OPTION

An alternative option to purchasing the flexible tubing would be to install a low-cost PVC pipe, which could be replaced if the basin height were adjusted.

However this would require a plumber, whose labour rate is higher than that of a general maintenance person. Using one tradesperson to carry out customisation work reduces doubling up on call-out costs in the future.

KEY CAPITAL COSTS TO PLAN FOR:

- ➔ height adjustable brackets
- ➔ flexible PVC tubing
- ➔ longer mirror

MINIMAL CUSTOMISATION COSTS:

- ➔ labour to height-adjust bracket only
- ➔ labour does not require any specialist skill

FLEXIBLE SHOWERSCREENS

Plastic curtains in bathrooms can be problematic for users with reduced physical capabilities, as wet fabrics can stick to the body and be difficult to control when showering independently or with assistance. Glass showerscreens do not pose this problem and provide a more homelike look, common in multi-residential developments.

The accessible bathroom design includes two showerscreen types, which can be used in different ways to provide flexibility in shower customisation, as well as in daily use.

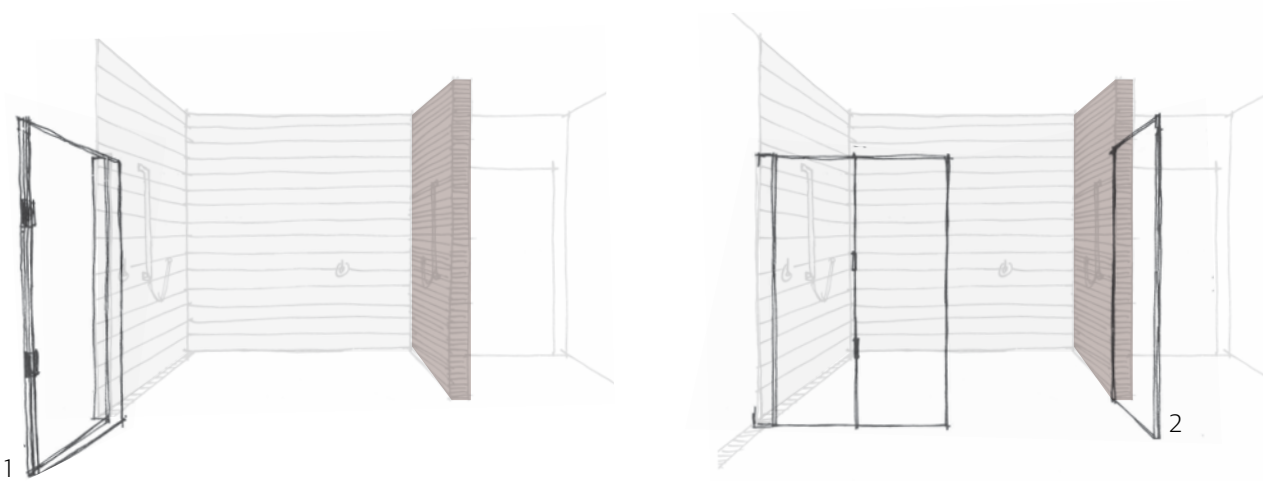

1. Hinged glass showerscreens are provided in all accessible bathrooms, providing more circulation space if needed in the shower, particularly when entering or exiting.

2. Optional fixed glass showerscreens can be easily added if additional circulation space is not needed.



Foldable showerscreens (Abbotsford) enable flexible use, and achieve a homelike look. Continuous tiling and silicone fixing allow for ready addition or removal, without damaging surfaces.

FLEXIBLE DISPLAY VERTICAL CUPBOARD

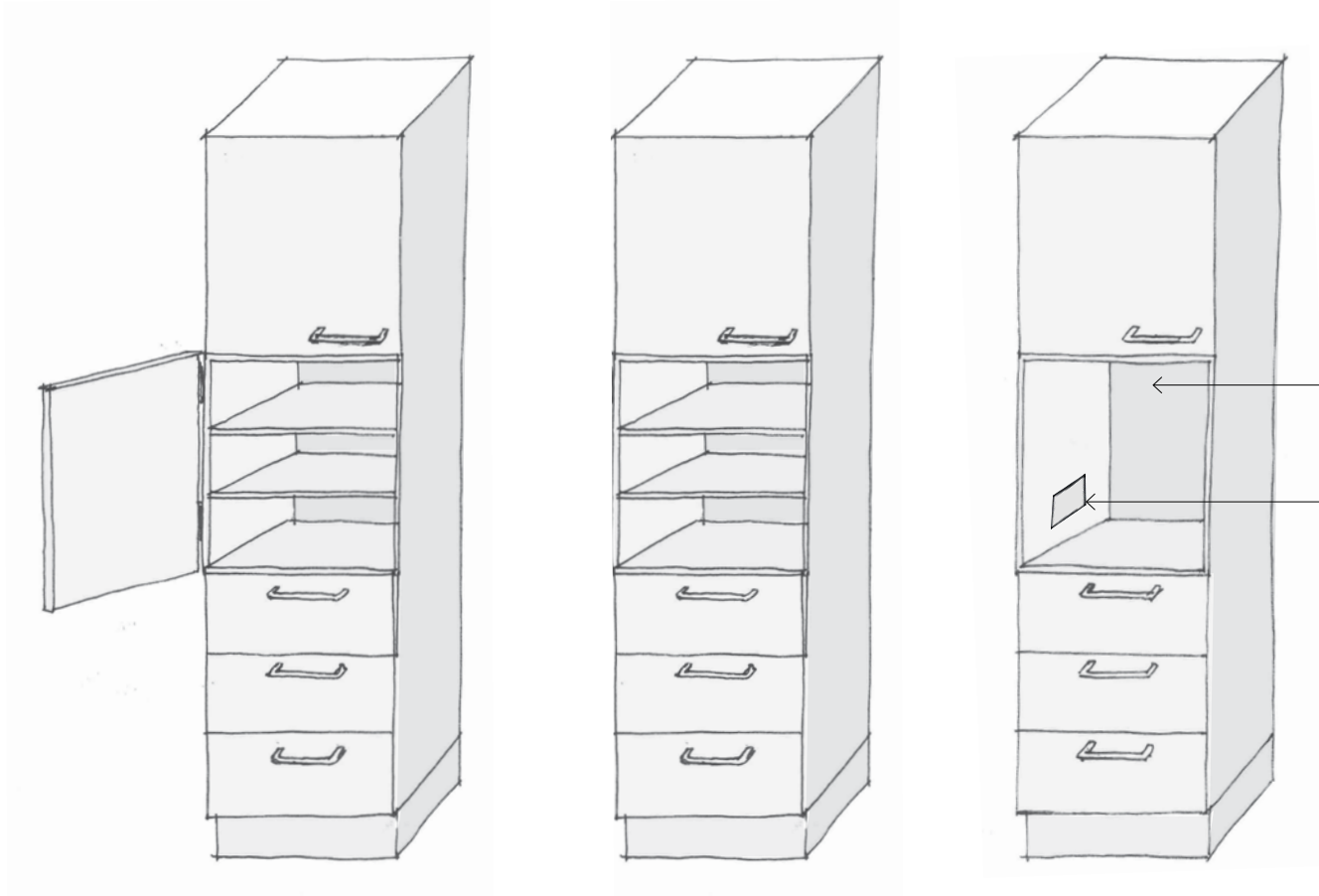

Accessible Bathrooms feature a vertical storage cupboard, which provides storage at a range of heights, to suit either a seated or standing user.

The central door may be simply removed off its hinges, to provide easier access to everyday items. To keep future costs low and retain a seamless look, the external unit is white, which ties in with standard white melamine used internally.

← adjustable shelving can be easily removed to improve access to items or to store larger items if needed

← GPO preferably side-mounted to improve access for those with limited reach

KITCHENS



Open-plan Living / Dining / Kitchen, Hunter Demonstration Project, Display Suite.

- Open plan kitchens maximise options for maneuverability and configurations for food preparation and dining, which is particularly important for people in large motorised wheelchairs and for those who require approach from one particular side.
- A galley kitchen layout will generally be most accessible, due to lack of difficult corners.
- An L-shaped kitchen can work where a galley kitchen cannot be achieved.
- U-shaped kitchens can limit flexible room configurations and ease of movement for users in larger motorised wheelchairs.

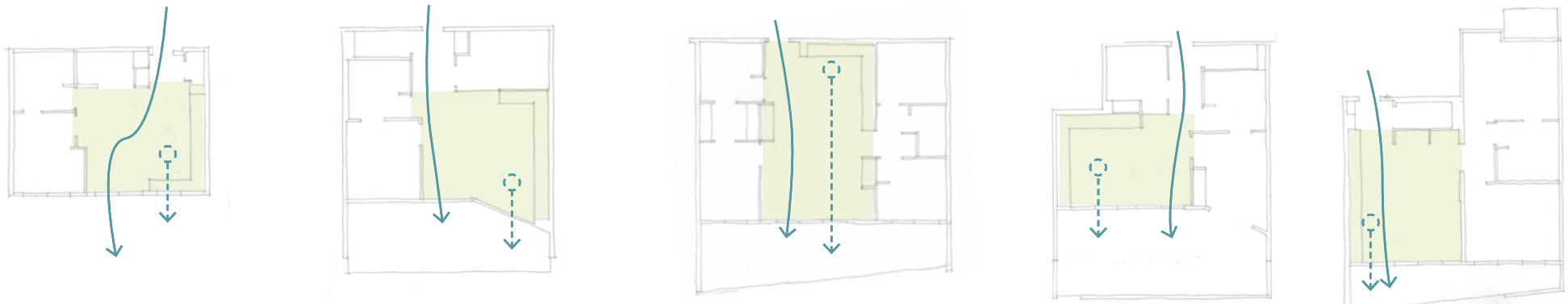

KITCHEN TYPES

Open plan Kitchen / Living / Dining areas in the Hunter Demonstration Project's 5 apartment types. The kitchen is located to fit this open plan area, preferably in linear form, or L-shaped where necessary.





Large open plan combined Living / Dining / Kitchen, Abbotsford

LHD PLATINUM RATING REQUIREMENTS

✓ task-lighting above work-areas

✓ 1550 mm clear between fixed benches

✓ non-slip flooring

DESIGN TIP

Consider the number of movements to access an item; i.e. a pull out bin is simpler to access than a bin in a cupboard.

IMPROVED FEATURES TO SUPPORT SAFETY WHEN LIVING INDEPENDENTLY

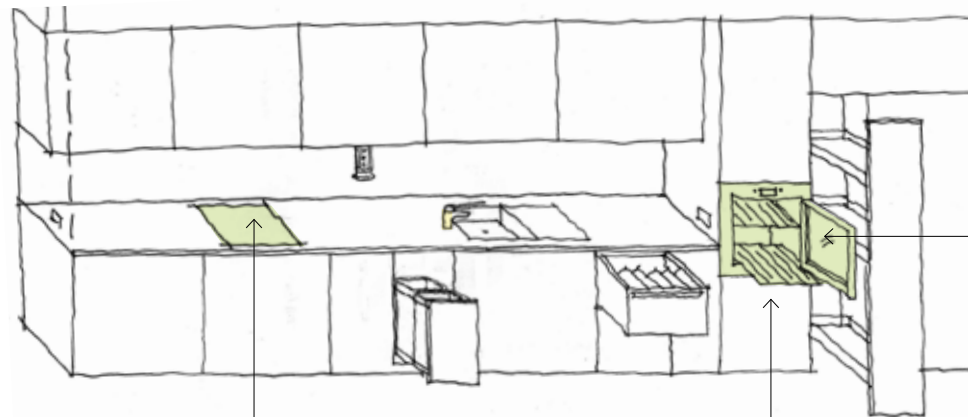

Induction cooktop reduces risks associated with gas cooking and naked flames.

Burn-proof glass insert in pull out tray below oven reduces chance of spillage and burns.

Side-opening oven can be either left or right hinged to better suit a user. Telescopic shelves reduce the need to put hands inside oven and the risk of burns.

ACCESSIBILITY FEATURES

Pull-down GPO unit provides more accessible power where no side mounting is possible.

GPO's are side-mounted for easier access.

Laminate benchtop allows for retrofit of side-mounted tap if required.

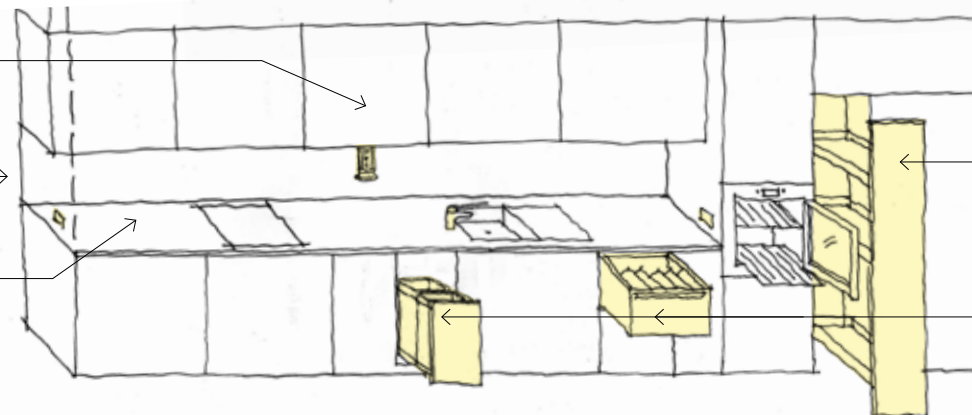

A pull-out pantry offers good access to storage and works well in apartments where space can be limited. A narrow model limits weight loading and potential difficulty in opening, for those with limited arm strength.

A pull-out bin and dishwasher drawer reduce bending for both seated and standing users



Dishwasher drawer, Abbotsford.



Pull-out pantry and tray below oven, Abbotsford.



Pull-down GPO unit, Mission Australia (Victoria) housing, MSM Architects.

CUSTOMISABLE BENCHTOP HEIGHT

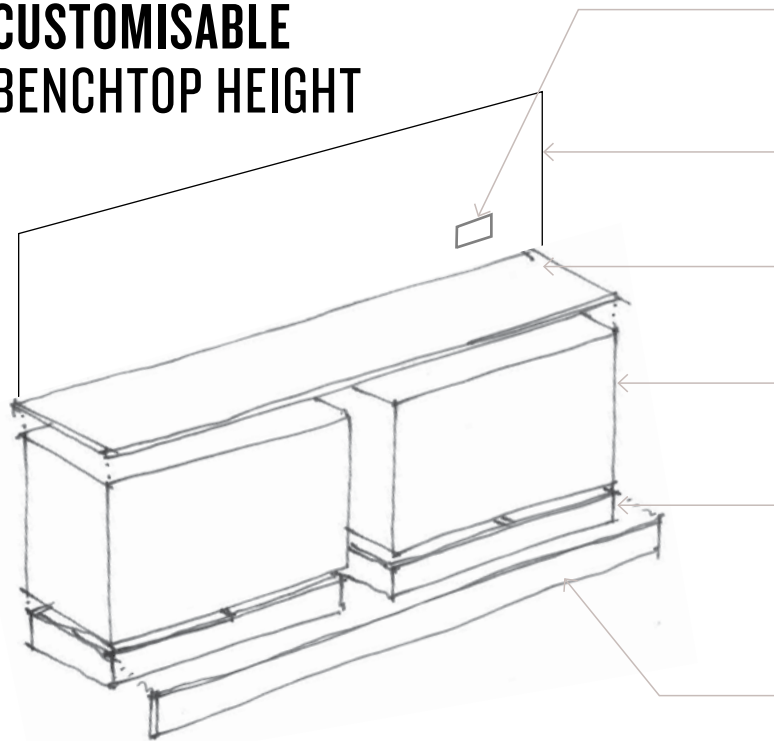

GPO is located at 1100 mm high to allow for benchtop to be raised to a maximum of 1000mm high.

Splashback continues below benchtop to allow for benchtop to be lowered in future if needed

Although not as durable, a laminate benchtop is more lightweight and more easily lifted and re-positioned to an alternative height than stone surfaces

Cabinetry units enable ready re-positioning at alternative height

MDF-plinths are cost-effective to build and replace if new benchtop height required, height-adjustable legs with adequate range are an alternative solution.

Standard 100mm high laminate kickplate lifts out and is cost effective to replace with a taller or shorter kickplate.

To improve use by either a seated or standing user, the benchtop height is designed to be customisable. Adjustment occurs by raising or lowering cabinetry units and altering the height of the kickplate to suit.

The advantage of this method is that the whole benchtop can be easily lifted, or portions only, to suit a kitchen for users with different requirements.

Installation needs to take into account future customisations, e.g. the rangehood is installed 100mm higher to ensure a minimum clearance of 600mm between underside of cupboards and cooktop in future, if the benchtop is raised to 1000mm high, meeting relevant building standards.

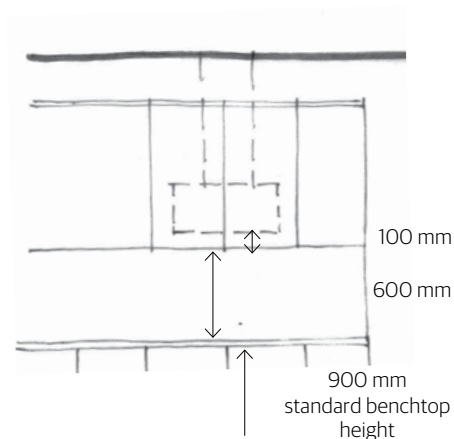

HEIGHT-ADJUSTABLE BENCHTOP

In a household with multiple cooks and varied access needs, key features such as the sink and cooktop may be integrated into a height-adjustable benchtop, with manual winder.

Removable modular cabinetry below provides options for knee clearance. Fittings need to be flexible in height to allow for movement e.g. flexible PVC piping at the sink.

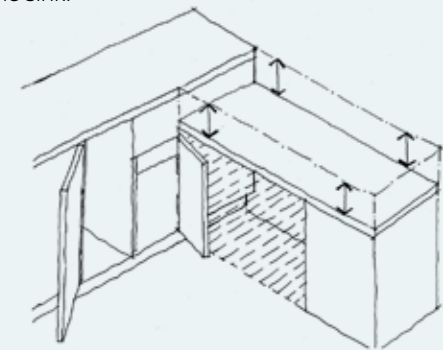

INCREASED CAPITAL COST TO PLAN FOR:

- ➔ higher splashback than standard (800mm instead of 600mm)

CUSTOMISATION COSTS TO PLAN FOR:

- ➔ labour to re-position cabinets & benchtop
- ➔ supply and install of new mdf plinth and kickplate

UNDERSINK AND UNDERSTOVE REMOVABLE CABINETRY

Installation of undersink and understove cabinetry lends kitchens a mainstream look as well as valuable storage space.

These underbench units are built as independent units, so as to be easily removable in the event that underbench knee clearance would make benchtop space more usable for an individual, and to be easily reinstalled, if an apartment is resold on the open market.

To save potentially unnecessary cost, these units are provided in half of the Hunter Project apartments only, with the assumption that underbench knee clearance will benefit at least half of the prospective tenants.

The units are designed to be modular, enabling the potential for swapping of units between apartments to suit tenant needs.

- ✔ extend flooring below all joinery to allow for future adaptation

It is important to check that wall surfaces behind removable joinery are adequately finished. This will reduce the amount of patch up work when cabinetry is removed.



Removable cabinet below sink, Abbotsford

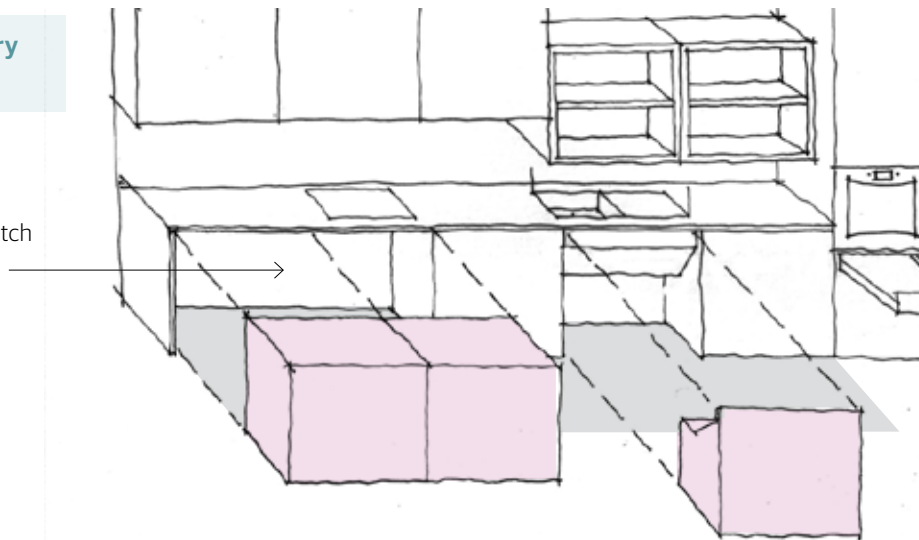

ROTATABLE SINKS

In kitchens where space is limited and a multi-sided approach to the sink and bowl is not possible, rotating the sink may increase use for a person with a preferred side.

A symmetrically designed, top-mounted sink can be rotated most easily without affecting the location of a centrally-installed tap.

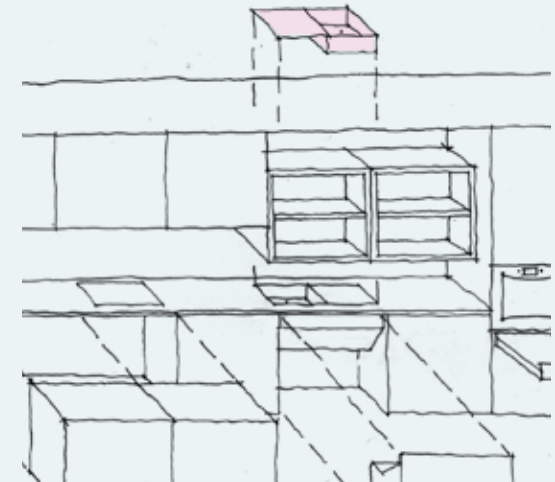

OVERHEAD OPEN SHELVING UNITS

panel filler above shelving unit can be added or removed depending on unit installation height

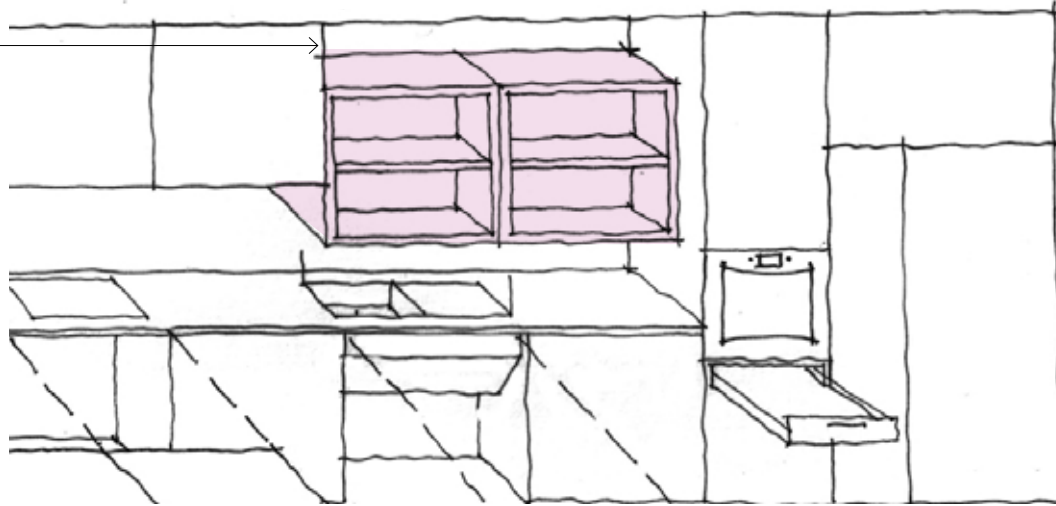

Use of standard overhead cupboards also lends the apartments a mainstream look, providing storage space accessible by standing users, while retaining higher benchtop clearances useful for larger appliances.

To minimise future adaptation costs (required to fully lower all overhead shelving to suit a seated use and subsequently to re-adapt for resale on the open market) a portion only of this shelving is designed to be easily lowered.

Particularly in 2 or 3 bedroom apartments it is anticipated that kitchens will be used by both seated and standing users.

Additional accessible overhead storage may be cost-effectively added (and removed) via the use of suction-cap shelving or screw-in hooks (e.g. for mugs).

The portion of overhead shelving designed to be lowerable is open, providing convenient access to everyday-use items, as well as a mainstream visual feature in the kitchen.

It is important to consider the location and dimensions of any fixed items when making allowance for future lowering, such as the tap height below overhead shelving or the length of LED strip lighting provided.



Overhead Shelving Unit in lowered position, Mission Australia (Victoria) housing, MSM Architects.

CUSTOMISATION COSTS TO PLAN FOR:

- ➔ (optional) supply of large infill panel above overhead open shelving unit
- ➔ call out fee & labour to remount shelving unit at lower height and fit filler panel

L-SHAPED KITCHENS

TYPICAL L-SHAPED KITCHEN AND DESIGN CONSIDERATIONS, HUNTER DEMONSTRATION PROJECT

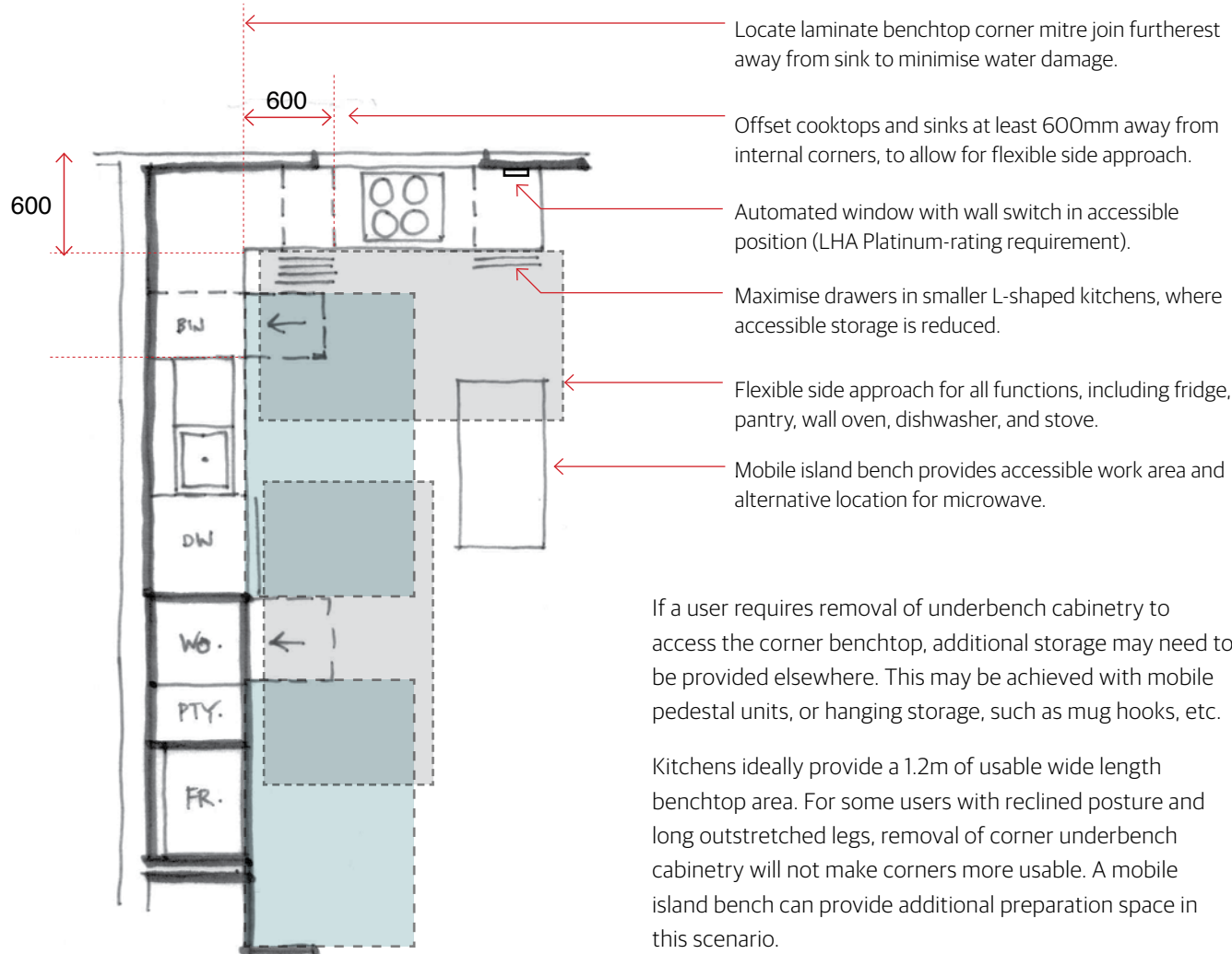

KITCHEN CORNERS

Kitchen corners are square-shaped (rather than chamfered) to look like standard apartments. Below are a variety of options to improve access and use of corners.

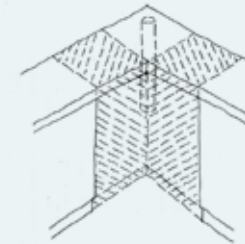

Removable corner cabinet modules provide knee clearance for wheelchair users.

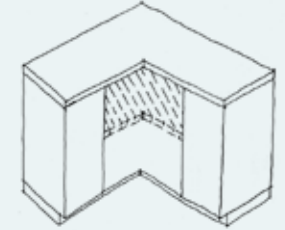

Removable internal shelf assists those wheelchair users with a reclined posture.

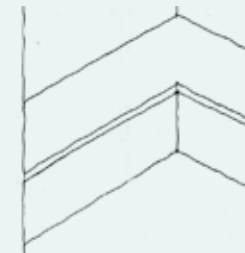

Where sufficient storage is available, kitchen corners may be left empty underneath, providing a flexible seated work area that is highly accessible for most users.

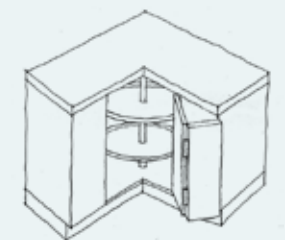

Proprietary products such as lazy susans can make corner storage more accessible. Systems that fully fold out are available however these are more costly.

MOBILE ISLAND BENCH

A mobile island bench can provide additional accessible benchtop area and storage if needed. Finishes and accessories can be used to blend the bench into the overall kitchen design.

Lightweight laminate benchtop and minimal componentry makes bench lighter to move. Benchtop size kept to a minimum maximises circulation space (e.g. 1360 x 600mm).

Toughened ABS edging prevents chipping, and rounded edges prevent injury.

Towel rail at accessible height provides options for easy-to-access storage.

In-slab GPO & pop-up GPO point in the benchtop allows for use of appliances, such as a microwave.

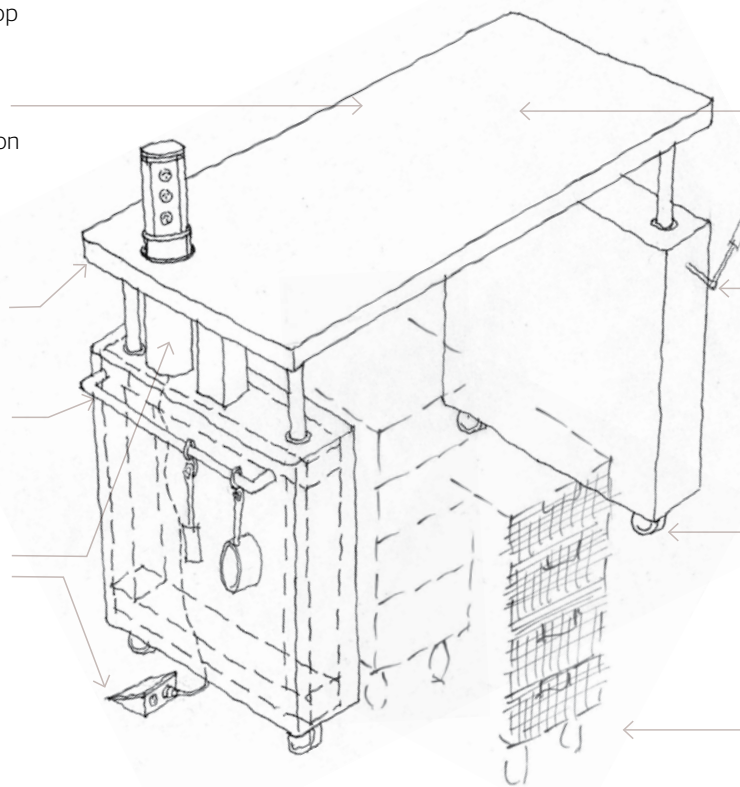

Welded frame minimises need for lateral brace at low level and increases durability.

Manual winder allows benchtop height between 720-1020mm high, for use by either a person in a smaller manual or larger motorised wheelchair.

Heavy-duty castors with brake (wheelchair user may need assistance to reach brake, so bench may not be regularly moved).

No in-built storage, for the ability to add most accessible storage for a particular user, saving potentially unnecessary cost and weight.



GPO point

A pop-up or pull-down power unit provides visible and easy to access power points.

ALTERNATIVES

Proprietary mobile desks may be a more cost-effective solution than a custom-designed island bench. To date we have not yet identified a product with necessary specifications, i.e. centrally-located brace bar and suitable height adjustability range. Electric push button operation would be more usable by a wider range of people but this function will increase cost.

Custom-made units manufactured in bulk quantities may reduce the per-unit price.

CAPITAL COSTS TO PLAN FOR:

- ➔ \$3800 - \$4700 for one height-adjustable bench
- ➔ \$800 - \$1000 for in-slab GPO

CUSTOMISATION COSTS TO PLAN FOR:

- ➔ none, height can be altered manually using the winder

DETAILED DESIGN CONSIDERATIONS



Smaller mobile island bench, at lowest and highest benchtop heights, Abbotsford.



Benchtop dimensions are ideally kept small to keep bench as movable as possible and to maximise kitchen circulation area.

A side-mounted bracing bar will allow accessible use from one side only.

Example of a limited reach range - a full height vertical bank of drawers would be largely unusable for this user.

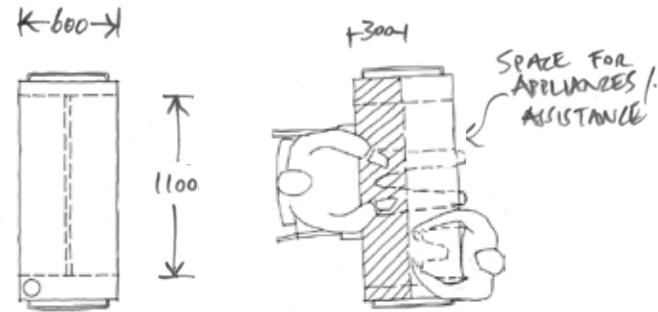

Benchtop doesn't need to be very deep to be usable, particularly for users with limited reach.

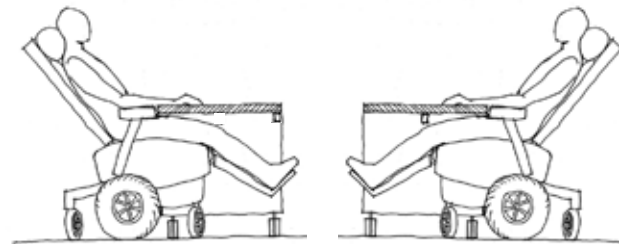

Providing a central bracing bar will allow flexible use from either side, (providing more options for one user, or allow two users to work together).

A deeper bench may be able to double as an accessible dining table if space is limited.

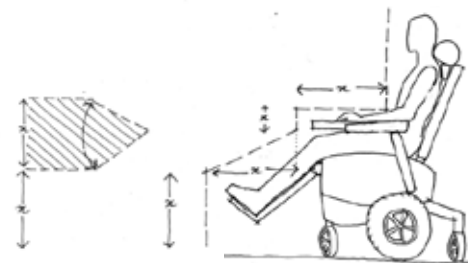

Example profile of a large motorised wheelchair user.

Different users will have different profile dimensions depending on their working position and use of mobility aids. These need to be considered when detailing the adjustable height range and construction of the bench.

ACCESSIBLE BEDROOMS

LHD PLATINUM REQUIREMENTS

- ✓ 1540mm wide path in direction of travel
- ✓ window sill no higher than 1000mm above finished floor level to enable view
- ✓ at least 10sqm in area, with minimum wall length of 3m
- ✓ 1000mm wide path to one side and at end of bed (bed dimensions based on typical queen size 1530 x 2030mm)

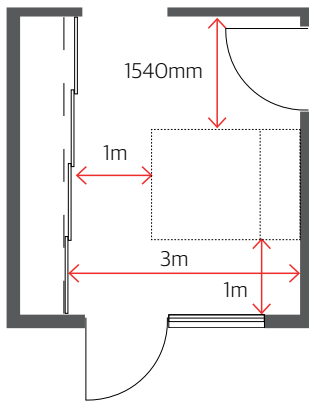

ADDITIONAL DESIGN CONSIDERATIONS

Ideally powerpoint provided, to enable a charging location for mobility devices away from view and circulation

Dense weave carpet for homelike feel and trafficability by wheelchairs

Stackable doors for selective display, flush threshold to floor guides for improved wheelchair access, multiple doors are lighter and easier to move for people with limited strength

Re-locatable wardrobe units

Maximum storage area to cater for increased storage requirements (i.e. bulk products, assistive equipment)

Powerpoint in BIR to allow for flexible set up of television / computer

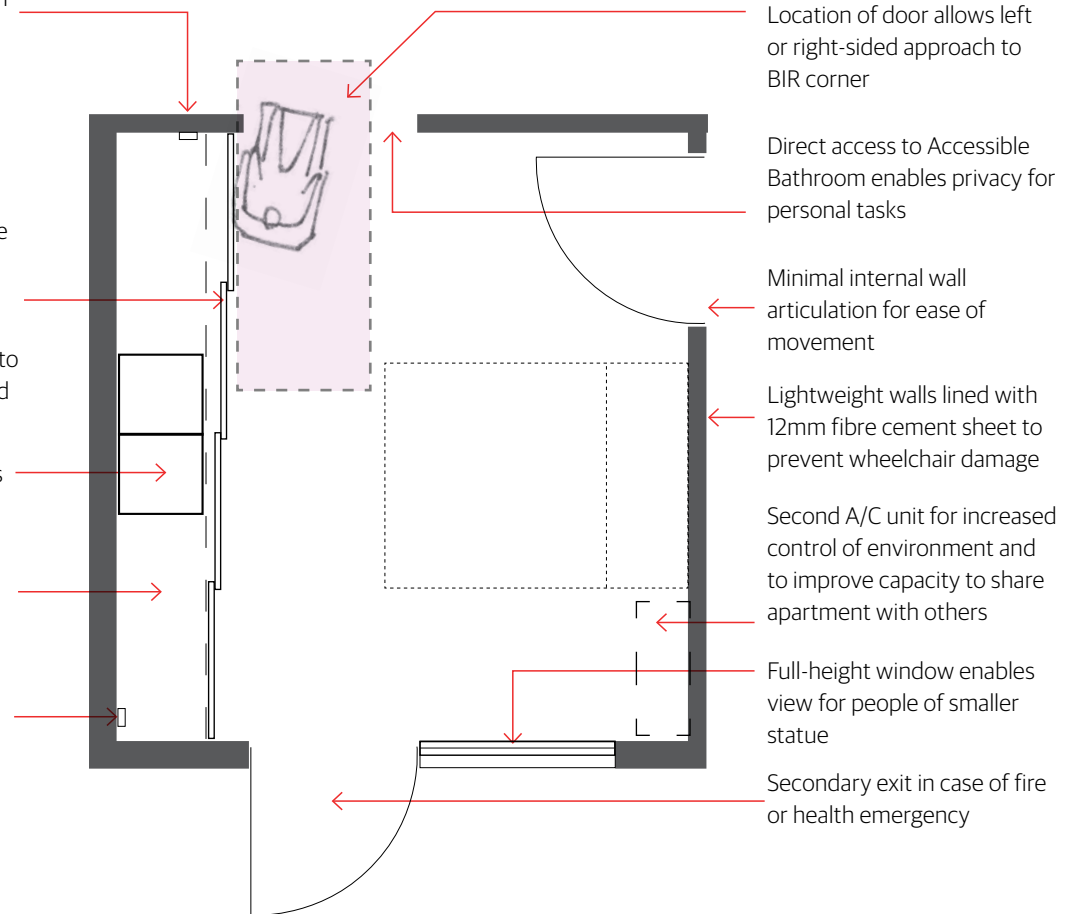

FLEXIBLE BIR LAYOUT



Standard BaseBuild bedroom with full-height sliding BIR doors. The number of doors and materials are different in Summer Foundation apartments, for improved control and reduced cleaning requirements.



Flush BIR floor threshold, Mission Australia (Victoria) housing, MSM Architects

Built in Robes (BIR) are designed to be easily customised to better suit an individual's access needs and preferences.

Height-adjustable shelving

Tower units not fixed in place (unsiliconed) to enable easy re-positioning for better access if needed.

Flexible-height hanging space

Wire baskets to easily find contents

Lightweight, shatter-proof doors with reduced cleaning requirements, one mirrored panel only, which can be located in the most convenient position.

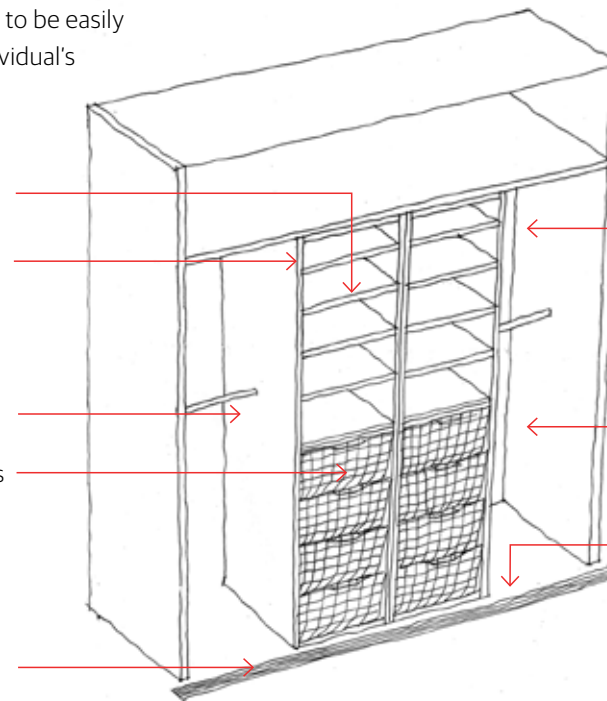

Supports concealed in ceiling to enable retrofit of hoist

Full-height 12mm ply sheeting to non-concrete walls, enables retrofit of grabrail supports to assist a standing user.

Continuous flooring allows for tower units to be easily repositioned.

Top hung doors with low floor guide enables wheelchair access close to storage.

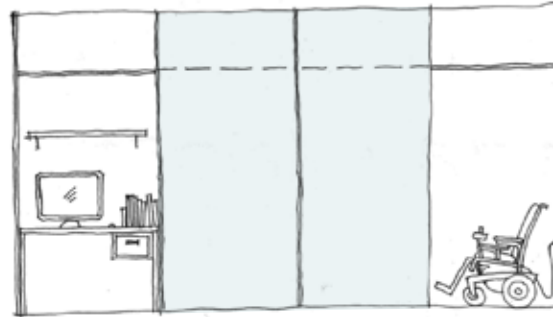
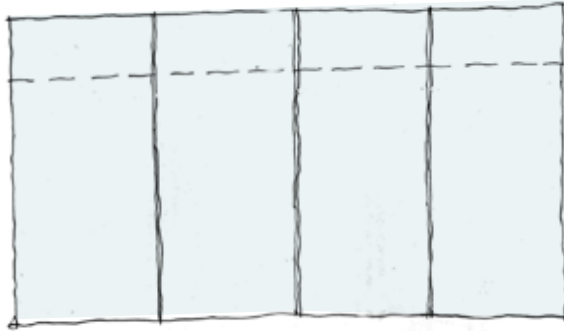

FLEXIBLE BIR DISPLAY

Lightweight BIR doors can be stacked in any direction to offer flexibility in how the storage area is used, as well as a user's desired level of privacy. Full-height sliding doors are common in apartment developments and are unlikely to incur additional cost. For 4 doors to all fully retract to one location a second double track is required.

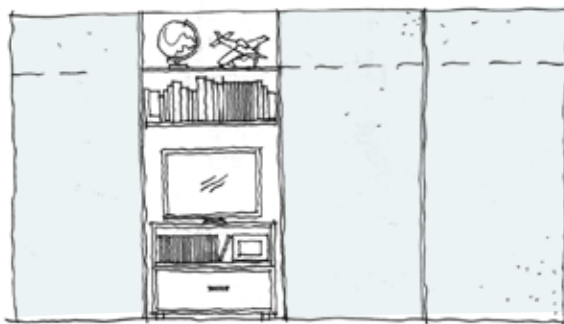

INCREASED CAPITAL COSTS TO PLAN FOR:

- second set of heavy duty doors & sliding tracks (for BIR's with 4 door panels)

CUSTOMISATION COSTS TO PLAN FOR:

- labour to reposition tower unit
- supply & install new hanging rod if needed

PRIVATE OUTDOOR AREAS

RAMP REQUIREMENTS

One level surface between indoors and outdoors via flush-level doorway thresholds and use of strip-drain (building code alternative to step-down)

GPO ideally able to be accessed from either side, located at 600mm high.

A/C unit located out of view

Raised garden bed between 700-950mm high

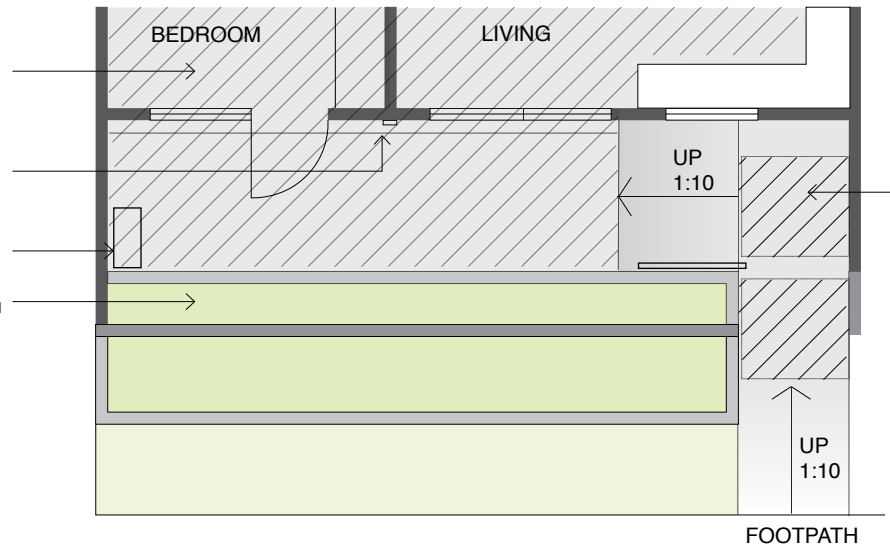

Ramping may be needed to provide a step-free entrance from street level.

LHD Platinum rating requires at least 1.5 x 1.5m level ground area on either side of the gate (1.2m in length needs to be clear of the gate swing). This prevents a wheelchair user rolling into or away from a gate.

Where space is limited to achieve 1.2m in length clear of the gate swing, a sliding gate may be used, which has no "swing" area, unlike a hinged gate.

Wheelchair users with limited reach may find a sliding gate easier to use than a hinged gate.

Horizontal openings in an automated sliding gate (i.e. horizontal slatting) can help to reduce the risk of hands being caught in the gate and injury occurring.

LHD Guidelines refer to AS.1428 for ramp requirements. Slopes must not exceed 1:14, however if space is limited, steeper ramps under 1900mm in length can be used (max. 1:10 slope).

The main focus of outdoor area design is removing barriers to access and free movement, particularly for large motorised wheelchair users.

RAMPING PRINCIPLES

- keep ramping as simple as possible for legibility and ease of use
- maximise flat areas for ease of wheelchair users
- avoid step ramps at door entries as steep ramps require a large amount of strength for manual wheelchair users
- if possible, provide additional area at the end of a ramp to allow a wheelchair user space to stop
- strip-drains should run perpendicular to wheels so that wheels don't get caught in wider gaps

WINDOWS AND DOORS ONTO OUTDOOR AREAS

ACCESSIBLE BEDROOM

External doors are provided to Accessible Bedrooms to allow an alternative escape path during a fire or health emergency (not for convenient everyday access). Those doors located on an escape path (i.e. ground floor or LO1 podium level apartments) automatically unlatch during fire, and can be easily pushed open without automation.

A door on its own could provide both alternative emergency egress and natural ventilation, but it is cheaper to automate an awning window (several hundred dollars) than a door, hence an awning window is also provided. This provides a cost-effective way to control fresh air in future, where automation is needed.

Turning circle of 1.5m allows for smaller or larger motorised wheelchairs

Open area provides flexibility for either pull-out or fold-down clothesline at preferred height

450mm high (from higher ground surface) bench provides a ramp upstand as well as a place to rest or place a washing basket, reducing bending.

Provisions for a handrail if required in the future

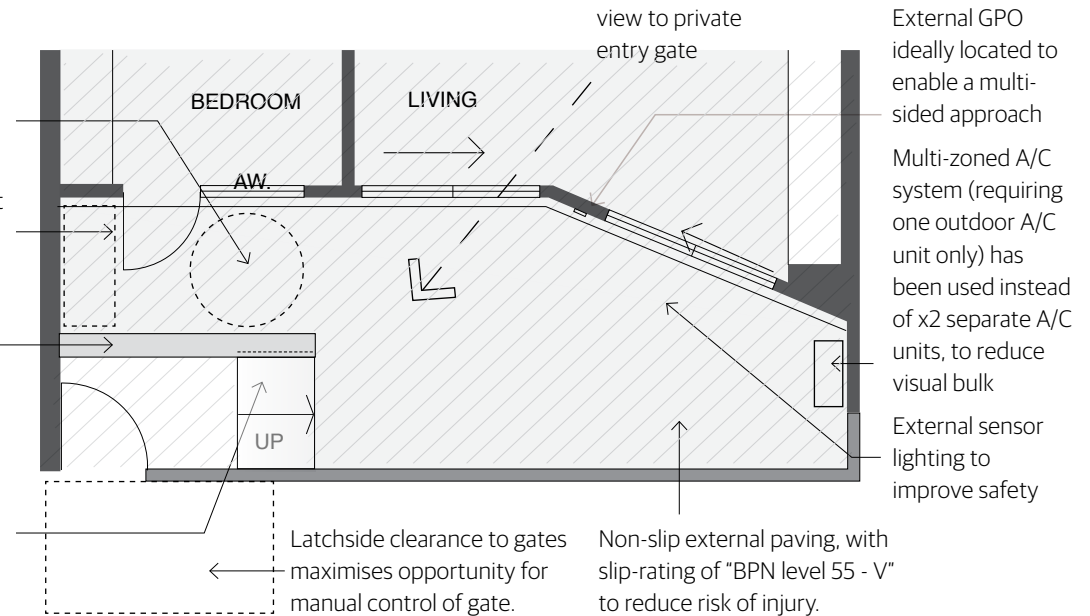

LIVING SPACES

- Sliding doors provide increased amenity and circulation space in outdoor areas although cost of automation hardware is higher than for hinged doors (\$4000 vs \$5000).
- Sliding doors are more likely than hinged doors to be manually operable for occupants with limited reach (not requiring automation).
- Double-opening sliding doors can increase the use of narrow outdoor areas by providing more circulation space (shown right).

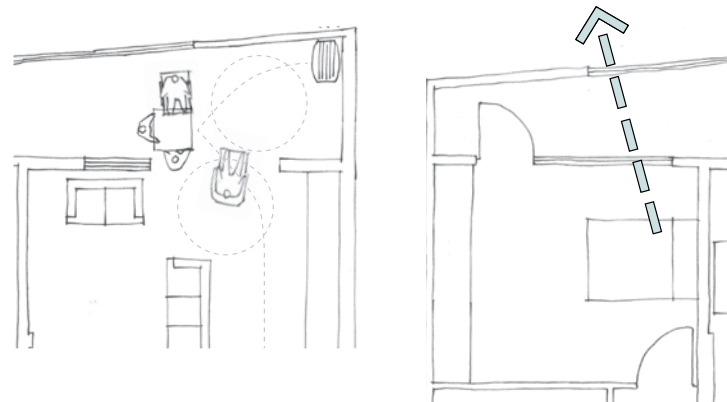

EXTERNAL VIEWS

Incorporation of glass into a concrete balustrade allows for a view out from the Accessible Bedroom and Living Spaces, for people with smaller stature.

OTHER SPACES AND PROVISIONS

The following sets out various insights into important features and considerations of other spaces and provisions in each apartment. As in all projects there are sometimes trade-offs in space allocation and features, due to space and budget considerations.



LAUNDRY

- Appropriate height positioning of washing machines and dryers reduces bending for standing users and improves access for seated users. Allowance for future height adjustment of these units may be made through provision of proprietary shelving units, which can be easily removed for lowering of the washing machine and dryer.
- Use of a side-sliding laundry tambour door with handle mounted at an accessible height allows for improved manual control of these doors for wheelchair users.
- Water taps and power point located at an accessible height / position increase user safety and control.
- Where underbench clearance cannot be provided to laundry tubs (e.g. where storage is preferred) the allowance for a side approach is important, to enable use by a wheelchair user.
- Consideration of pull-out ironing boards and clotheslines which enable a wheelchair user to roll under may be useful for future projects (not been included in current projects).
- Ceiling-mounted gimble downlights, which can be tilted to an appropriate angle, can be used to achieve the LHD Guidelines task lighting requirement to laundries, rather additional spot lighting.
- Design of laundry setups may need to integrate joinery with overflow and waste points.

Abbotsford Housing Demonstration Project, post tenant move-in modifications involved removal of laundry cupboard doors and replacement of doors with side-sliding tambour door.

SECOND BATHROOM / POWDER-ROOM

- Providing a second bathroom in two-bedroom apartments supports a person with extended bathroom routines arising from their disabilities to more easily live together with a friend or family member.
- Providing a powder room (toilet) supports a person with extended bathroom time in having a friend stay overnight or have visitors.
- A second toilet at a minimum or second bathroom is increasingly commonplace in many apartment developments and is considered likely to add to the broader marketability of the property across time.

ENTRIES

- Privacy and accessibility are important considerations at apartment entries. Privacy can be achieved through the use of corners or doors offset from one another.

STORAGE

- A higher provision for storage is required than in standard apartments due to the potential need for bulky equipment and bulk supply of personal products.
- Storage incorporated into open plan layouts (i.e. not 'store rooms') is likely to be most accessible for most users.
- Linear storage (shown below) that abuts an open area with open space at either end can be more usable for people with limited strength on one side of the body. Careful positioning of door openings can help to create more space for maneuvering.
- Wheelchair users may have multiple chairs hence appropriate flexible storage space (with access to power charging) is useful.

SECOND BEDROOMS

- Second bedrooms which are 'enterable' (i.e. with adequate latchside door clearances as per AS1428.1) improves the ability for a parent using a wheelchair to enter a child's bedroom.
- Second bedrooms with sufficient levels of access can function as a study / store.
- Inclusion of a TV point can assist in creating a separate living zone, which can be useful for various individuals living together e.g. a person with disability with a family member or friend.



Linear storage supports flexible use and improved access.

E. IDEAL PRODUCT FEATURES

Close consideration has been given to the selection of appropriate materials, appliances, whitegoods, fixtures, fittings and services for accessible apartments.

Below lists a range of considerations and ideal features specific to our projects, based on learnings from the Abbotsford Demonstration Project and similar projects undertaken by others acknowledged in this report. Some examples of products specified for the Hunter Demonstration Project are included. Future projects will benefit from a review of new products on the market, which may open up further opportunities for increased independent use or more cost-effective customisation.

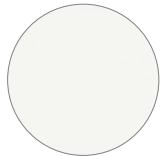

Laminex Metaline Panel Splashback



Laminate benchtop, 10mm radius edge

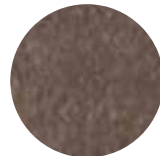

Ceramic Tile Skirting to Wet Areas (base build standard)



Tweed Carpet Tiles, direct stick to slab, no lining

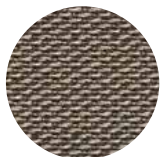

Woven Vinyl, Bolon Flooring, TAG, BKB Sisal Plain



Vinyl sheet flooring, Forest FX, Polyflor

MATERIALS

FLOORING

- ⚠ Slip-resistance of BPN 45 for wet areas
Avoid visually confusing patterns
- ↔ Hard surface to aid mobility
- 🕒 Heavy duty for extended product life
Impermeable backing to reduce spill damage
Resistant to pulling e.g. multi-layered carpet
Robust to withstand indentation from wheelchairs
Commercial warranty period
Low-tech cleaning regime
Repairable surface e.g. marmoleum
Modular product that can be replaced e.g. carpet tile
- 🏠 Residential look

WALL SKIRTING

- ↔ Thin material to maximise clearances (LHD guidelines measure between skirtings)
- 🏠 Avoid institutional-look coving to vinyl flooring

WALL LINING

- 🕒 Impact-resistant to withstand damage from equipment

SPLASHBACK

- 🕒 Continuous surface for easy cleaning (no grout)
Matt finish to reduce cleaning requirements
UV-resistant, to prevent a fade line if benchtop lowered
- 🔧 Able to be cut on site - enables alterations

BENCHTOP





- 🕒 Impact-resistant
Stain-resistant
Heat-resistant
Easily replaced if damaged
- 🔧 Lightweight, to allow for re-installation at altered height

CABINETRY MATERIAL

- 🕒 Chip-resistant

APPLIANCES



OVEN

-  Insulated or multi-layered door to reduce risk of burns
Telescopic pull-out trays reduce need to reach inside oven
-  Side-opening oven to reduce need to reach over door
Left or right hinging to suit user preferences
Lightweight doors without heavy seals
-  Pyrolytic (self-cleaning) to reduce maintenance
-  Visually simple controls and commands with few steps

POSITIONING

- *Locate at benchtop height to suit greatest number of users*
- *Locate directly next to benchtop for transfer without lifting*
- *Provide underbench clearance directly adjacent if possible*

COOKTOP

-  Electric preferred over gas (no naked flames)
Induction cooktop loses heat quickly once items removed
Pot detection feature (only heats up where pot is placed)
Automatic safety switch detects excessive heat
-  Controls and burners close to front to reduce need to reach
3 burner in linear layout (if space permits) reduces reach
Flat buttons allow pots to be easily slid onto benchtop
Touch controls useful for users who cannot twist controls
-  Audible signal
Visually simple controls and commands with few steps

RANGEHOOD

-  Graphically simple controls and limited commands

POSITIONING

- *Mount separate control button to joinery at accessible height*
- *Locate GPO in accessible position if possible*
- *Consider minimum vertical clearances if benchtop raised*



Bosch Side-opening Oven
HBL43S450A

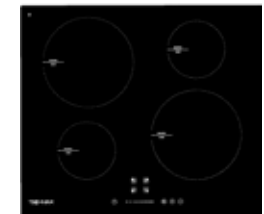

Technika Induction Cooktop
TGC6IND

KEY



SAFETY



CUSTOMISABLE



ACCESSIBILITY



UNDERSTANDABLE



LONG TERM COST



HOMELIKE

WHITEGOODS

FRIDGE

- Flipped fridge-freezer for easy access to everyday items
 - Low-level freezer drawers reduce need to lift heavy items
 - Separate units at accessible height if space permits
 - Left or right handed model to suit user preference
 - D-pull handle allows for easier grasp than indented handle

POSITIONING

- Allow circulation space for side approach from either side



Fischer Paykel
Active Smart Fridge
E402BLXFD4



LG 30L Solo
Microwave Oven
MS3042G

MICROWAVE

- Non built-in model allows for positioning to suit user's reach
- Large clear buttons with limited commands

POSITIONING

- Provide benchtop space adjacent to reduce need to lift
- Avoid placing above benchtop height to reduce risk of burns



Simpson Stainless Steel
Drum Dryer 5kg
39S500M



Bosch 7kg
Front Loading Washer
WAP24160AU

WASHER DRYER



- Front loader reduces the need to reach
 - Combined washer/dryer if space is limited
 - Consider button and soap tray accessibility
 - Ease to open door and operate buttons
 - Separate vented dryer can be flipped to reduce reach
- Simplicity of steps (many combined units are complex to use)
- Energy and water efficiency reduces running costs
 - Mainstream brand with good warranty
 - Robust design e.g. doors and trays that slide in if knocked

POSITIONING

- Allow clearance for side approach from either side
- Taps in accessible location
- Firmly fix in place if mounted on plinth to maintain warranty

FIXTURES

SINK

-  Shallow sink suits users with limited reach
-  Tray insert in a standard sink possible if user's reach limited

POSITIONING

- *Locate as close as possible to bench edge to reduce reach*





Haefele Squareline Sink





Dorf Oasis Veggie Spray Kitchen Sink Mixer with Care Lever 2757.044A, 90997C

KITCHEN TAP

-  Low outlet to minimise splash and maximise water pressure
- Rotating head for pots / kettle to fit beneath the tap
- High-necked spout useful if user's reach / strength is limited, combined with sink insert, allows for sliding of pot beneath
-  Specify well-known brand for ready replacement of parts
-  Clear temperature identification

SHOWER

-  Hose type, with adjustable shower head mounting height
-  Replaceable head type to enable fitting of specialist heads
-  Water efficiency reduces running costs

POSITIONING

- *Mount hose suitably high to avoid hose hanging in water*



Con-serv Premium hose/ shower rose/grab rail, HS 018-03 C2 2m hose

KEY

- | | |
|--|--|
|  SAFETY |  CUSTOMISABLE |
|  ACCESSIBILITY |  UNDERSTANDABLE |
|  LONG TERM COST |  HOMELIKE |

FITTINGS

BASIN

! Model with overflow (less important if floor waste provided)

Avoid metal traps which can burn bare legs

↔ Shallow model to maximise underbasin knee clearance



Caroma Opal Sole
Semi-recessed
Basin 631610W



Con-serv Premium Straight Grabrails,
HS HS1200 PS



Suction Cap Shampoo Holder

TOWEL RAIL

! Model which doubles as a grabrail

↔ Double-rail provides additional storage at accessible height

SHOWER SHELF

🔧 Suction cap-type allows for positioning to suit individual

HANDLES

! Rounded edges to prevent injury

↔ D-pull style for easy grasp

🏠 Slim profile for mainstream look

EUROPEAN LAUNDRY DOORS

↔ Sliding tambour door allows easier access than hinged doors

Left or right opening to suit user's preferences

D-pull handle mounted at accessible height for easier grasp

Easy glide to suit users with limited strength

🕒 Heat and moisture-proof slats (e.g. aluminium-look plastic)





Hettich Avenio D-Pull
Handles, 9070521



Surteco Roller Shutter,
side sliding roller shutter,
Silver R711,
Duo 30/11

SERVICES

AIR CONDITIONING SYSTEM

-  Compatible with Home Automation System
Split System for good level of temperature control
Multi-head system to allow different heating/cooling zones
-  Multi-head system is less bulky than 2 separate single heads
-  Remote control offers flexibility but wall panel cannot get lost

POSITIONING

- Avoid constant direct airflow over users e.g. above beds
- Locate in central position for good airflow



HOT WATER SYSTEM

-  Provide thermostatic mixing valve for temperature adjustment (adjusted periodically by a plumber)
Wall buttons enable frequent temperature adjustment (only compatible with gas hot water systems)



SETTING

- Set temperature to maximum suitable for individual user (low temperatures require more cleaning of pipes)
- Legislation limits maximum temperature to 50° in bathrooms,
- 50° maximum temperature in kitchen and laundry optional
- 50° setting through all apartment requires one TMV only, allows safe use of all water fixtures throughout apartment

LIGHTING SYSTEM

-  Provide sensor lighting to private external entries for safety
-  Capacity to link into Home Automation System
Dimming lighting can be plugged in if needed, via GPO's hence dimming function not essential
Avoid illuminated light switches which may cause agitation

INTERCOM SYSTEM

-  Capacity to link into Home Automation System
-  Handsfree type with push-button (no lifting of phone needed)

KEY



SAFETY



CUSTOMISABLE



ACCESSIBILITY



UNDERSTANDABLE



LONG TERM COST



HOMELIKE

F. TECHNOLOGY

As outlined earlier in this report, a range of smart home technology has been incorporated into our demonstration projects to support tenant independence.

The technology component of projects is complex and evolving, due largely to the fast pace of change in this field. Project specifications evolve rapidly in this context, within and between projects, based on new product available, and the specific building context in which a project may be developed.

In order to provide some insights into the technology aspect of our projects that are more constant, we have included on the following pages extracts from our key performance outcomes and broad specifications for the technology system.

In the Appendix we have also included one working diagram, which can be used to break down how these outcomes may be achieved.

EMERGENCY COMMUNICATION SYSTEM

An emergency alert and two-way hands free voice communication system is required in all Summer Foundation apartments which includes the following features:

- Must be reliably available 24 hours a day and when normal power supply fails
- Multiple options required for tenant to alert staff in an emergency, including pendant, alert button on tablet/ smartphone and wall duress button
- Two way hands free ceiling mounted microphones to be in all main rooms of apartment
- When activated by tenant they must receive a confirmation back (ideally via voice message/recording, image and vibration) confirming that their call has been sent to support staff
- Calls to be responded to by support staff from support staff apartment or from other location on or off site via mobile phone (i.e. need option to divert to mobile phone as staff will not always be in support staff apartment)
- If no response from staff, need the capacity to divert to multiple phone lines, either to the same line in sequence (with appropriate relay time) or various lines simultaneously
- Alerting options will need to address diverse disabilities and capacities of tenant group (e.g. people with limited dexterity in their hands, cognitive disabilities)
- Logging of all calls, their source and response times is required and the support staff manager able to access the log

HOME AUTOMATION AND MONITORING SYSTEM

Infrastructure and programming that will enable full or partial operation of home automation and safety/monitoring features in each apartment that can be operated from a range of devices such as tablets, smart phones and IR (InfraRed) or WiFi devices is required.

A system that is robust enough to prevent interference from other systems in the building or local vicinity is required. In addition, a back up electrical system is required for essential features. Advice on options for run time, minimum load capacity and cost is required to support decisions about the best option.

The range of features to be controlled in each individual apartment through a smart home technology system include:

- private entry gates (if private entry gate provided), entry doors, accessible bedroom door and bathroom doors off living/kitchen area)
- lighting
- air conditioning (two way communication capability with home automation system required)
- window opening and closing
- window blinds
- tenant is able to communicate with and permit entry to people at building entrance wanting to visit them

(preferably using existing building intercom system with capacity to operate through tablet or smart phone as a component of the home automation system)

- remote door opening including ability to open building entry door (and any other doors or lift required in path of travel) to allow a visitor to enter an individual apartment

Each apartment must have the capacity to have all automated features installed if required for individual tenants. However, it is unlikely that all tenants will need all features of automation, so each individual apartment will need its own configuration of enabled features i.e. power to be provided to all doors that might require automation, but automated doors may not be required in all apartments and only on some doors in the apartment.

A log of use of all features on an individual apartment basis is required to be accessible for monitoring by support staff manager and for evaluation purposes.

Other features required include:

- Motion sensors in strategic locations that can activate alerts to staff e.g. when no activity in bathroom between 6am and 11 am
- Water sensors in kitchen and bathroom that can activate alerts if flooding occurs

- Temperature monitoring and alert if temperature falls outside a set range within specified rooms
- Ability to monitor opening of entry door/s to individual apartments as required (e.g. alert is sent if apartment door does not open within 15 minutes of the time a staff member should be arriving to provide essential assistance). These alerts need to be programmable for individual apartments and to be able to be switched on and off easily by support staff manager, in line with agreed arrangements with the tenant

All features that are automated will also need to be able to be concurrently operated manually, independent of the home automation system. That is fixed lights operated through wall switches, air conditioner operated through manufacturer provided infra-red remote control or blinds operated from switch on wall.

The capacity to install the full system or individual components needs to be available for all apartments. Cabling to support the base system needs to be installed in all 10 apartments during construction. Individual features will be incorporated based on the needs of the specific tenants moving into each apartment. This may occur after the properties have been handed over, or in advance of this.

SYSTEM FEATURES – EASE OF OPERATION

ADJUSTMENTS (FLEXIBLE AND SIMPLE DESIGN)

It is essential a support service staff member trained in the system can undertake the following:

- easily activate or de-activate specific features for individual tenants for a short or long period of time e.g. de-activate temperature alerts when person in holidays or in hospital
- set specific monitoring/alerting regimes e.g. when a person is sick, be alerted if door to apartment does not open within 10 minutes of time staff expected to be there
- run reports from the logs
- set, change and add features linked to the system in individual apartments (e.g. person may not usually need the light control function – but their disability has worsened and they now need that function activated for the apartment)

SYSTEM STRUCTURE (STANDALONE APARTMENTS)

Each apartment must have home automation technology set up independent of other apartments so the system in each apartment can be tailored for each individual tenant. The system needs to be able to be easily de-activated in an individual apartment to facilitate sale of apartment or rental to non-participating tenant if required in the future.

USER INTERFACE (CLEAR AND RESPONSIVE DESIGN)

The user interface with the automation system must be simple, intuitive and give immediate feedback (i.e. letting the person know that they have shut or opened the door.) It needs to be usable by people with physical disabilities, as well as cognitive disabilities i.e. may only be able to learn and use one feature at a time. The user interface should be able to communicate via as many sensory means as possible to suit a variety of abilities i.e. providing feedback with sound, vibration, or images if required.

LIFT OPERATION (ALTERNATIVE CONTROLS)

It is anticipated that some tenants may not be able to manage the lift call and lift control function buttons due to not being able to reach them or not having sufficient strength to push them from a distance. Therefore we need capacity for all lift control functions to be operated in an alternate way. Functions that need alternate control capability include:

- Call lift/open door
- Floor selection
- Door hold-open
- Close door
- Emergency call

This capability needs to be provided as part of initial lift installation.

SYSTEM UPGRADES (SUFFICIENT PROVISIONS)

The system needs to be flexible to cater for a range of circumstances including:

- Future upgrades that may be required to connect to new technologies/services that may become available
- The need to interface with alerts from safety or medical monitoring equipment such as epilepsy mats, falls detectors, heat sensors
- The need to interface with infra-red devices for people who need such devices

Sufficient provisions are needed to enable the upgrade of home features to motorised use or control via the Home Automation System. To keep unnecessary cost low, these provisions should be the minimum, that allows for easy upgrade of full automation at a later stage. Examples include:

- pre-wiring for future addition of motorised blinds to all bedroom windows, with a blank cover plate (allows for easy identification and access to wiring in future)
- no air conditioning interface provision, as this can be easily added at a later stage to each apartment's standard technology hub
- electric strikes (enabling automatic door unlocking) to all apartment entry doors, as future addition to fire-rated entry door panels and concrete walls is cost-prohibitive.

G. LINKING INDIVIDUAL CAPACITY WITH BUILT ENVIRONMENT

Within an apartment designed to universal design principles, some building features will still need to be adaptable, to support ease of use by individuals with specific physical skills and abilities.

Opposite is an outline of some of the key physical capacities that may vary between individuals, and hence can impact on apartment requirements. This list has been developed through the process of identifying and implementing necessary building modifications in the Abbotsford Demonstration Project. This process was undertaken with the assistance of occupational therapists, familiar with issues commonly experienced by people with disability, particularly with acquired brain injuries.

This list is not comprehensive but provides examples only of the various skills / abilities which need to be considered when designing an environment that allows for customisation in response to individual tenant capacities and disabilities. We anticipate that this list will be further developed in the Hunter Demonstration Project through collaborative work with occupational therapists and following a post occupancy evaluation.

It is important to ensure that occupational therapists and other therapists supporting individual tenants are informed of any inbuilt provisions for future customisation, as this may impact whether they recommend building alterations or provision of equipment.

Positioning of grabrails (above) and provision of cabinetry under stoves (below) was determined based on individual tenant requirements, Abbotsford.



G. LINKING INDIVIDUAL CAPACITY WITH BUILT ENVIRONMENT

PHYSICAL ATTRIBUTE	CONSIDERATION	POTENTIAL IMPACT IN BUILT ENVIRONMENT
MOBILITY	Is a wheelchair used? Manual, large motorised, both?	Inclusion of kitchen under bench cabinetry Additional storage to compensate for lost storage if under bench cabinets removed
	What mobility aids are used which need to be stored?	Wardrobe layout
	Would removal of under bench cabinetry make the bench more usable as a workspace? (If a person is particularly reclined in a chair or uses a larger chair, removal of under bench cabinetry may still not allow close enough access to the workspace)	Inclusion of corner under bench cabinetry Mobile island bench may be better solution than removal of under bench cabinetry
	Is the person ambulant, but needs support standing?	Install of grab rails to built in robe Install of grab rails to shower Install of grab rails to toilet Length and position of grab rails
	Is there a risk of falling in the shower?	Turn on shower water flow alert Set to individual expected shower time
	In what position would the kitchen most be used, and using what kind of wheelchair, if any?	Bench top height adjustment
	In what position would the bathroom basin most be used, and using what kind of wheelchair, if any?	Bathroom basin height adjustment
	What equipment (if any) is required for showering and what is the associated amount of clearance required?	Installation or removal of fixed glass shower screen
	Length of time / complexity to navigate unit entry / exit?	Time delay setting for an automated unit entry door
	Length of time / complexity to navigate lift entry / exit?	Time delay setting for lift door
	Are many activities undertaken from bed?	Install of TV within BIR configuration Wall-mounting of TV

PHYSICAL ATTRIBUTE	CONSIDERATION	POTENTIAL IMPACT IN BUILT ENVIRONMENT
STRENGTH (PREFERRED SIDE)	Is the person left-hand or right-hand dominant?	Toilet position Sink orientation Tambour door sliding direction
STRENGTH (TO SELF-TRANSFER)	Able to self-transfer in / out of bed, to couch, to therapeutic aids such as massage bed, other? Is a hoisting zone needed in multiple rooms?	Installation of ceiling hoist system Extent of ceiling tracking system Install of single ceiling hook if transfer is to one discrete point only (i.e. a favourite armchair) Selection of mobile or fixed hoist (tracking does not extend between 2 rooms)
REACH AND DEXTERITY	Comfortable reach range? (depth, height and able to twist) Consider seated and standing positions. Is the emergency communication wall button suitably located if emergency communication access is essential while in bed? (pendant also provided)	Install height of kitchen overhead shelving modules BIR hanging rails install height Kitchen mixer tap length adaptations Wall-mounting location of any individual controls Type / location of toilet-roll holder (wall-mounted or mobile unit) Install of toilet flush automatic sensor Height of clothing hook Bathroom tower cabinet (door/no door) Height install of washing machine and dryer Provision of emergency communication via tablet (i.e. wall-mounted in suitable location)
SENSORY ABILITIES	Ability to safely control use of hot water? Level of sensitivity to hot water? Will smoke alarms be audible? Would high or low temperatures pose serious health risk? Does the person have adequate sense of smell to distinguish gas? (if gas supply provided)	Water temperature setting (not relevant where a TMV is installed with pre-set maximum temperature) Inclusion of visual alerts to smoke detection system Turn on heat sensor alerting Individual setting of max and min alert temperatures Turn on optional gas alert (if alert provided)

G. LINKING INDIVIDUAL CAPACITY WITH BUILT ENVIRONMENT

PHYSICAL ATTRIBUTE	CONSIDERATION	POTENTIAL IMPACT IN BUILT ENVIRONMENT
TOILETING	Does the person use a toilet for toileting? Are guests with mobility issues likely to visit?	Install of DDA-compliant toilet Install of standard toilet
STRENGTH (DEXTERITY)	Manual control of doors possible? Windows? Blinds?	Upgrade to automation, with control via wall switches and/or tablet
	Manual control of kitchen pantry possible?	Addition of touch-to-open automation hardware
	Manual control of private entry gate possible? (radio frequency fob) Manual control of A/C (wall panel) possible? Manual control of intercom and light switches possible? (buttons)	Upgrade to operation via tablet
	Manual control of lift buttons possible? (also need to consider access / reach) Manual control of common area intercom possible? (also need to consider access / reach)	Upgrade to automated control (i.e. on tablet /smartphone)
	High degree of manual control of flywire door? (Important as there is no provision for automation and this is a potential second fire escape point)	Inclusion of flywire door to accessible bedroom
	Manual keying of letterbox possible?	Upgrade to automatic opening of letterbox via radio-frequency control
SUPPORT	What equipment is needed which must be stored within the apartment (as opposed to cage store)	Wardrobe layout
	Is essential support required on a regular basis?	Turn on "no-motion" alert (unit entry door and/or room motion sensors)
	Who needs to be called in case of an emergency?	Programming of individually designated phone numbers

H. ASSISTIVE EQUIPMENT TO SUPPORT EASE OF USE

Not all issues when designing for independence can be solved through relying on the inbuilt flexibility of built components in the apartment. It is impossible to pre-empt every possible individual capacity or need, and the more inbuilt flexibility provided to a fixed component will generally increase its complexity and cost.

Hence assistive aids may be more useful in supporting a task to be carried out independently, as they can be purchased specifically for individual tenant needs.

This may be useful to consider during the design of joinery, when detailed design may become more cost-prohibitive, and assistive devices can more effectively support a task. Input in the design process from occupational therapists will be highly beneficial in identifying where built designs can be simplified and assistive devices may be used to achieve a range of uses.

Shown here is an example of where assistive devices can work hand-in hand with accessible design for a home environment highly usable for a particular individual.

PHYSICAL ATTRIBUTE	CONSIDERATION	POTENTIAL IMPACT ON ASSISTIVE EQUIPMENT
STRENGTH, REACH AND DEXTERITY	Is the tenant able to effectively use a hand-held control device, such as a tablet? (If home automation is needed)	Informs technology device, size and whether a mounting arm is required for wheelchair or bed
	How much will the hand-held device be relied upon? I.e. where and when will it be needed?	A pendant for emergency call (around the neck) may be most appropriate
	Can the tenant effectively move the device from one location to another if needed in multiple areas?	A mounting arm, pouch or leg strap mounting system may be needed to mount a tablet or smartphone (Smartphone may be preferred as more portable than a tablet)
	Does the tenant have sufficient arm strength to transfer food in one movement from the oven to the bench top?	Trolley with heat resistant surface may be needed
	How will the tenant transfer the tablet / phone to a charging point?	An aid, docking station or charging device on wheelchair may be needed
	Does the tenant have enough strength to load/unload the washer-dryer?	A tipping basket on a trolley may be useful
	Is the tenant able to reach the washer soap drawer?	Liquid capsules or powder tablets that can be thrown in the drum may be useful

APPENDIX I | HUNTER PROJECT – APARTMENT FLOOR PLANS

The 6 Summer Foundation apartment floor plan types developed for the Hunter Housing Demonstration Project are provided here, for context of design issues discussed in this report, courtesy of MSM Architects.

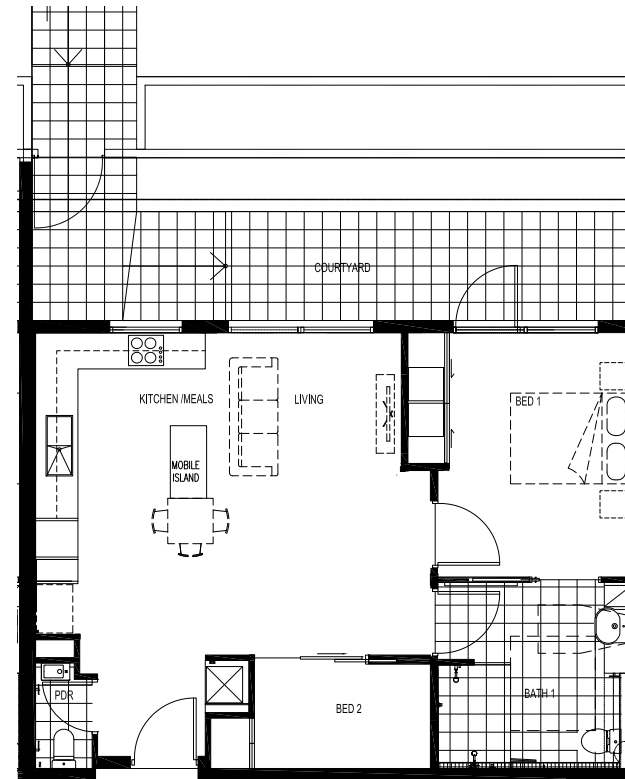

PLAN TYPE 1 | 70 SQM

0 0.5 1 1.5 2 2.5m

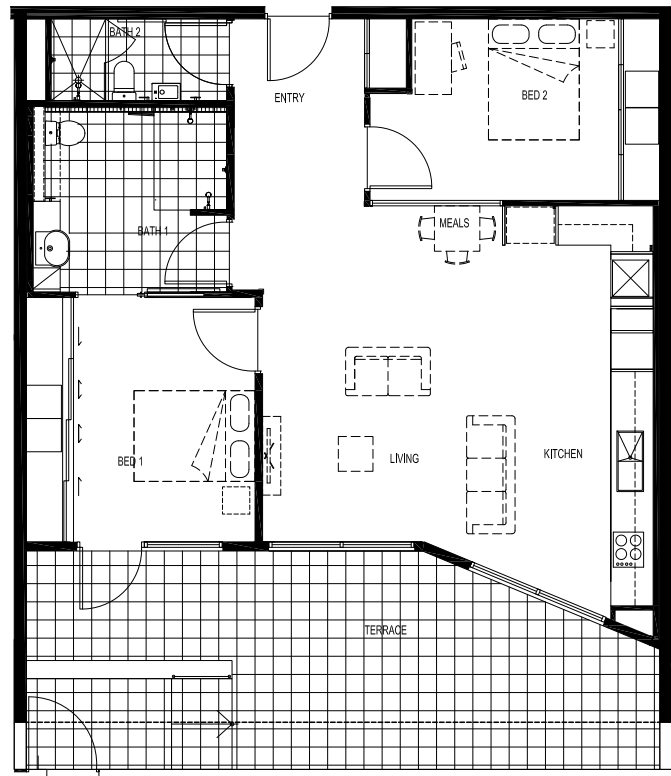

PLAN TYPE 2 | 93 SQM

0 0.5 1 1.5 2 2.5m

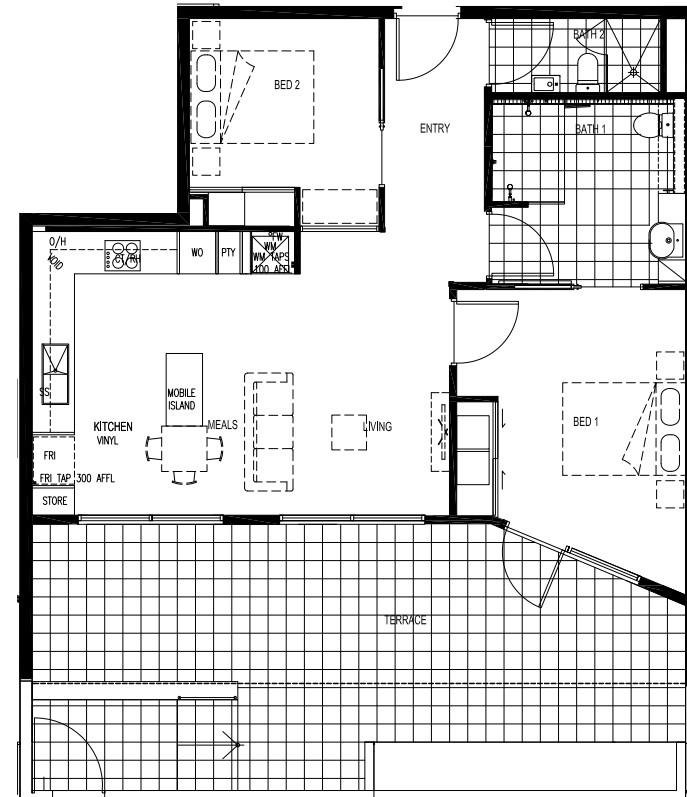

PLAN TYPE 3 | 81 SQM

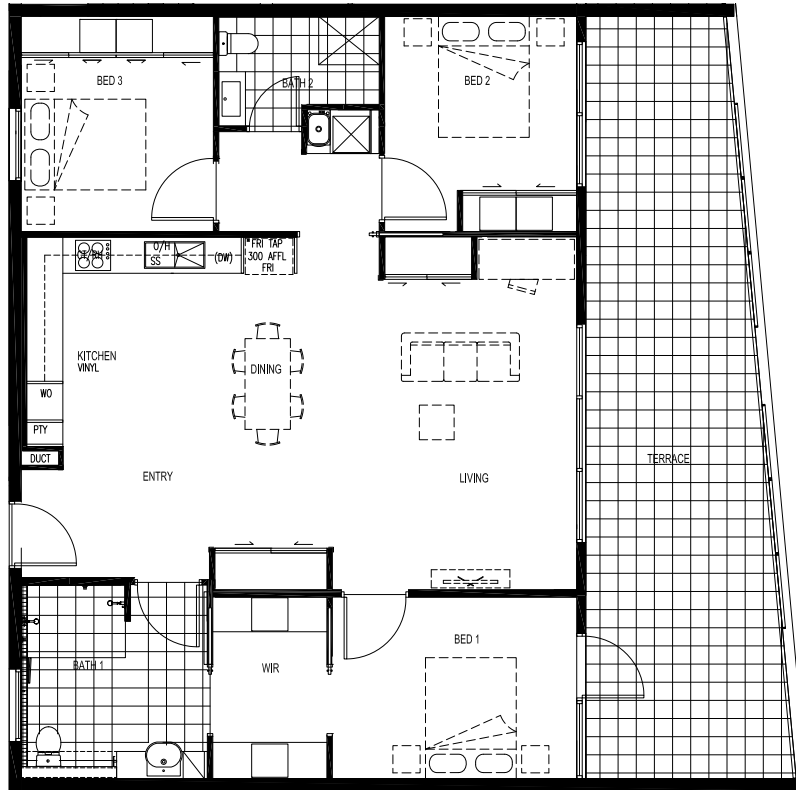

PLAN TYPE 4 | 114 SQM

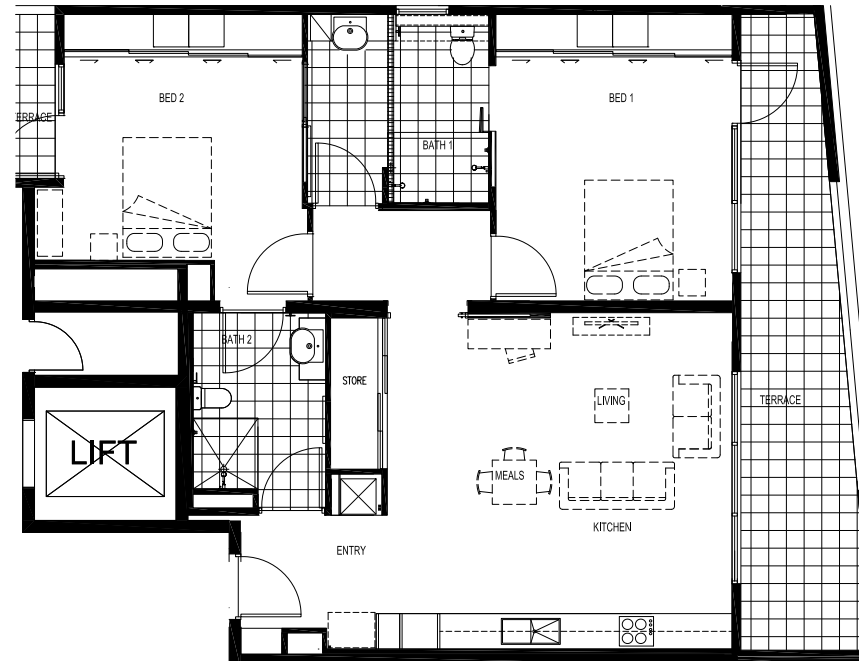
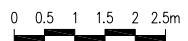

PLAN TYPE 5 | 106 SQM

APPENDIX 2 | PRINCIPLES IN DECISION-MAKING – JOINERY & WINDOW FURNISHINGS

DEVELOPMENT OF PRINCIPLES

During design development for the Hunter Demonstration Project, it was necessary to make several strategic decisions, taking into account factors such as:

- The degree of enhancements to be made to base build specifications
- The extent of accessibility to be achieved in the apartments and common areas
- Cost vs. impact of enhancements

Decision-making at a range of scales enabled general principles to be formed for the overall design, which could then be applied generally.

In general, clear priorities and principles will assist designers in making detailed design decisions, however it may be that these priorities and principles are identified and better understood only during the decision-making process. Hence it is useful to allow time for this.

We have included the two following sections on joinery and window furnishings, to provide an example of thinking, principles and specifications, which emerged through decision-making required for the Hunter Demonstration Project.

JOINERY PRINCIPLES

Extent of enhancements to base build specifications

- Any enhancements to the base building design specification must support increased independence; these must not only improve quality or general performance. Joinery should be of the same quality as standard base building apartments.
- More design attention and cost investment should be spent on parts of the design that provide the greatest scope of options for access e.g. a kitchen island bench offers more scope for access than corner cupboards.

Extent of accessibility

- It is still useful to include features, which are not accessible, as an addition to basic accessible provisions, such as kitchen overhead cupboards

or bedroom high-level shelving. This will maximise the use of space, provide a mainstream look to apartments, and support people with disability in sharing with family members or friends without disability.

Cost considerations

- Standard sized cabinetry (e.g. 300mm, 450mm, 900mm) should be used, where possible, to reduce costs. However accessible joinery design that supports independent use is of primary importance, hence kitchen joinery may be customised as needed.
- Where possible, modularity between apartments is useful, to enable swapping of optional cabinetry between apartments, as per occupant need, as this reduces upfront capital costs.

WINDOW FURNISHING PRINCIPLES

Considerable thought has gone into assessing which enhancements to basic window furnishings are actually essential features for people living with significant disabilities in the project apartments.

Window furnishings are not typically provided within the development as part of the apartment purchase. However, window furnishings are considered important for tenant security and privacy. Thus, due to the anticipated low income of many tenants and anticipated difficulties a number may experience in sourcing window furnishings for themselves, window blinds will be provided for all units.

Types of window furnishings to be provided

- Accessible bedrooms
 - Where it is not possible to view into the room, provide blackout furnishings only (to provide darkness for sleeping)
 - Where it is possible to view into the room, provide blackout and privacy blinds.
- Non-accessible bedrooms
 - Provide blackout blinds only (to provide darkness for sleeping)
 - Assumes a person with disability will not be exposed/undressed, hence no privacy furnishings provided
- Kitchen and living spaces
 - If it is possible to view into room from outside, provide blackout blind for security at night (support staff unit also)

Consideration of potential overlooking is needed, not only from existing planned buildings, but also from possible future construction of buildings adjoining the site.

Wiring / Automation Of Window Furnishings

- Provide wiring to all kitchen, living, and bedroom windows (internal and external) to allow for future installation of motorised furnishing if needed
- Double wiring to accessible bedrooms (allow for privacy as well as blackout blinds)
- Single wiring needed to all other windows (for blackout blinds only)
- Double-wiring for future wall switches to accessible bedrooms
- Single wiring for future wall switch to all other windows
- A double blind/curtain requires two automation wiring points and two power points

If costs need to be reduced, an option may be to reduce double-wiring to single wiring in accessible bedrooms, and reduce to blackout furnishing only (no separate privacy furnishing).

HUNTER PROJECT | UPGRADE PROVISIONS

A product has been identified (Uniline blind with Jai roller blind motor) that will allow for an easy upgrade from manually controlled blind to motorised blind, by adding the motor component at a later stage. This saves the cost of replacing the entire blind, which is often required when upgrading from manual to motorised blinds.

Manual blinds will be provided to all units (except for two display units, which will be automated) with provisions for a range of upgrades as required to suit varying abilities.

DESIGN TIP

It is important to remember to allow sufficient tolerance when allowing for future additions e.g. by providing 10mm space on one side of the blind to fit the addition of a future motor.

The following table identifies the range of upgrades possible:

INSTALLATION OPTION	ADDITIONAL COST TO CONSIDER
Manual blind - chain operation	None (base case)
Manual blind - spring loaded chain operation	Cost of spring
Motorised blind, wall switch control	Cost of motor + commissioning of wall switch
Motorised blind, wall switch control + remote	Cost of motor + commissioning of wall switch + cost of remote
Motorised blind, wall switch control + Home Automation (tablet/phone)	Cost of motor + commissioning of wall switch + programming

Upgrading from a manual to, for example, a motorised blind with the specified model is anticipated to be straight-forward, including the following steps:

- remove manual blinds from track (spring off)
- remove chain winding element
- install motor
- remount blind
- connect to power source

APPENDIX 3 | CEILING HOISTS

Below is a summary of our key learnings on the design and installation of various ceiling hoist systems, based on our experience of retrofitting a system in the Abbotsford Demonstration Project, other similar building projects, and further investigations into some of the available systems on the market. This has been included to assist others when specifying or making provisions for a ceiling hoist system.

We have also included a list of useful features of a hoist system for the target group of the Demonstration Projects, developed through discussions with occupational therapists and suppliers.

KEY LEARNINGS – SYSTEM TYPES

1. It is advantageous to provide adequate ceiling structure during construction, to allow for future installation of ceiling-mounted systems. This will allow:
 - For any ceiling hoist structure to be concealed, providing a visually seamless look
 - Design flexibility, as the location of structural supports (and hence hoisting zone available) will not be limited by the location of existing doors, windows or full-height joinery. (Note: wall brackets can be located above doors, windows and joinery, but wall studs require full-height wall access. We learnt from the Abbotsford Demonstration Project that it can be costly to remove joinery to gain access to walls for mounting of wall supports.)

Adequate in-ceiling structural support is generally straightforward to achieve in apartment developments with concrete slabs.
2. Ceiling cavity depth will impact on the dimensions and cost of in-ceiling supports; direct-fixed ceilings with minimal cavity depth may reduce the need for any in-ceiling support at all, as the future hoist may be directly fixed through the ceiling to the underside of the slab.
3. In-built ceiling provisions in deeper ceiling cavities may be either ceiling droppers, capped off at the ceiling lining for addition of surface-mounted tracks, traverse rail and hoist at a later stage, or droppers and recessed tracking, for addition of the traverse rail and hoist at a later stage.
4. Walls with continuous structural support (e.g. precast concrete panels or ply-lined lightweight walls) are advantageous, as these allow for the retrofit of wall-brackets in any location, without requiring full-height wall clearance as post systems do. Wall brackets may be located above windows, doors, and high joinery.
5. Wall-mounted systems in larger spaces will need deeper beams than ceiling-mounted systems, as a beam must span a longer distance between supports. A deeper beam reduces the clear ceiling height, which may impact on use of equipment, is more costly, and more bulky visually.
6. Installers prefer to install one single system throughout a project (i.e. all ceiling mounted, or all wall-mounted) as this reduces complexity, and may reduce installation time and cost.
7. The selection of flush-mounted fixtures and fittings (e.g. light fixtures or sprinklers) is important where ceiling hoist systems may be installed, to avoid potential clearance issues.

KEY LEARNINGS – HOIST FEATURES

HOIST TYPE / LAYOUT

- Tracks with a H-shaped layout provide maximum flexibility for movement
- A fixed track with a mobile hoist provides good flexibility, as this allows for a person to be hoisted into a wheelchair; the mobile hoist can be demounted and hooked to a separate stand-alone ceiling connection point (ie. above a lounge chair) - the ceiling structure needs to allow for stand-alone hooks to be positioned anywhere.
- A hoist which is compatible with different models of sling will more easily allow for changes across time

HANDSET FEATURES

- Hand control with adaptable length, to suit a variety of user
- Low tension cord connecting to hand-held control, for easy use by people with limited hand strength
- Simple hand control interface, easily understood by people with cognitive issues
- User-controlled hoisting speed
- Integrated weighing scale

HOIST FEATURES

- Unit rechargeable from any standard powerpoint
- Person being hoisted can control the hoist e.g. via a hand-held remote
- A hoist shape and number of sling connection points, which means a person's head does not get bumped or that they are squeezed in their sling (a curved hoist with 4 connection points can alleviate being squashed)
- Soft-start function
- Easy transfer of hoist motor from room to room, requiring little effort by those assisting.
- Emergency lowering and emergency stop
- Ceiling tracking that can be modified in the future if necessary
- Long handset chord, to reduce the user's need to reach
- Water resistant handset (if hoisting in wet areas)
- Monitoring of use function, for analysis & trouble-shooting
- Alert when servicing required, to potentially reduce scheduled maintenance frequency
- Flexible service options, to suit funding options and budget available



CLOCKWISE FROM TOP:

Wall-stud system (Ceiling Hoist Solutions) retrofitted at Abbotsford, Recessed ceiling hoist rails (HLS Healthcare); wider opening at one rail end allows for addition of traverse rail at a future stage and Wall bracket system TAC RIPL Housing.



HUNTER PROJECT | SPECIFICATIONS

The following broad specifications have been developed for the Hunter Demonstration Project, in response to the above learnings, as well as broader design considerations, such as supporting a range of future options and supporting dignity.

- The capacity for future installation of hoisting system to be made in accessible bedrooms and living areas, via provision of in-ceiling supports
- No capacity for ceiling hoisting in accessible bathrooms (it is anticipated that an individual requiring hoisting will transfer to a shower commode in bedroom)
- Provisions cater for future install of hoist with weight capacity of up to 263kg
- Ceiling-mounted GPO caters for either mobile or fixed hoist

APPENDIX 4 | EMERGENCY CALL WORKFLOW

The following 'workflow' is an example of a working diagram, used to develop the emergency communication system in the Hunter Demonstration Project.

Such a diagram can be useful in helping to identify potential inputs and outputs (i.e. tenant/staff devices) and what hardware / programming will be needed to achieve desired outcomes.

It can also help to highlight potential conflicts between what the technology is normally used for, and what is needed in the context of the Housing Demonstration Projects.

- Logs required:
- Log all calls and their source
 - Log response (Answer) times

Notes / Questions:

Support Staff phone should have DID (Direct Inwards Dialling) to allow tenants to contact Support Staff when outside of unit (lift, hallways, parking lot, supermarket etc)

Call priority – what happens when support staff is on a call and another tenant requires immediate help? The system could call waiting pips, enabling the support staff to switch calls and determine urgency.

Does the tenant have the ability to cancel a call?

Call Point Workflow

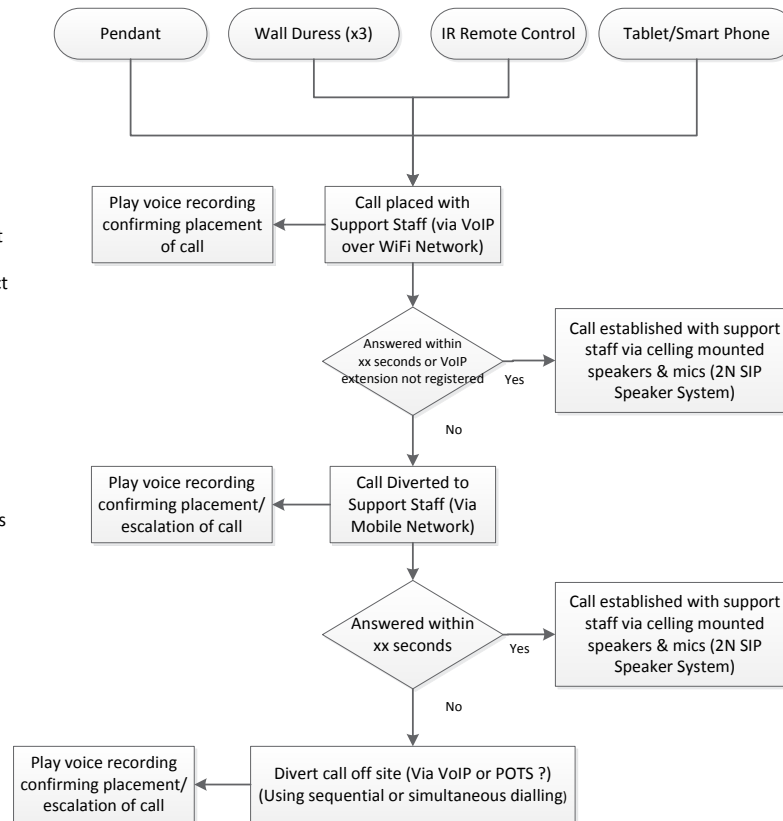

Call is initiated by either RF Pendant, Wall mounted Duress buttons, InfraRed Remote Control or via Tablet/Smart Phone. *IR Remote Control or Tablet/Smart Phone initiated calls should not be relied upon in emergencies*

Tenant hears message confirming call has been placed. The call to the support staff is first attempted over the local WiFi network using Voice over Internet Protocol (VoIP) to the support staff's phone and to a desk phone in the support apartment.

If the support staff answer the call, a two way call is opened up with the tenant.

If the support staff do not answer the initial VoIP call, the call is then placed via the mobile phone network. This will help reaching the support staff if they are not in WiFi range (outside of apartments) or not in the support apartment.

If the call (via the mobile phone network) is answered, a two way call is opened up with the tenant.

If the support staff do not answer the mobile call, the call is then diverted off site to multiple numbers. This could be in a sequential fashion, or simultaneously.



SUMMER
FOUNDATION